

User manuals Cloud system



USER MANUALS CLOUD SYSTEM

IMPORTANT DISCLAIMER

Z-wave wireless communication is inherently not always 100% reliable, and as such, this product should not be used in situations in which life and/or valuables are solely dependent on its functions.



Vitrum Design s.r.l

Via Filippo Brunelleschi, 16 - 20146 Milano

Mail info@vitrumdesign.com

Tel +39 02.65560373

Site www.vitrum.com



INDEX

DIN RAILS

DIN II Dimmer Cloud	4
DIN HVAC Cloud	6
DIN IV Double Shutter Cloud	8
DIN IV On-Off Cloud	10

EU 3M - 4M

EU I On-Off Cloud	12
EU II Single Shutter Cloud	14
EU II On-Off Cloud	16
EU III On-Off Cloud	18
EU IV Triac Cloud	20
EU VI Satellite Cloud	22
EU VI Triac Cloud	24
EU Clima Control	26

BS

BS I On-Off Cloud	28
BS II Single Shutter Cloud	30
BS II On-Off Cloud	32
BS IV On-Off Cloud	34
BS Clima Control	36

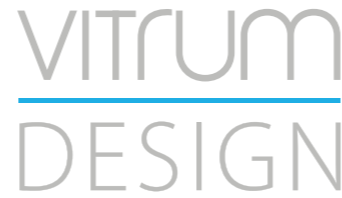

Model: RailZ-4M
Type: Dimmer-2CH
Code: 01D02H010
Protocol: Z-Wave Plus

INTRODUCTION

Purpose of this document

This manual describes the most essential functions and technical specifications to help the electrician to install, setup and control the device. It is a Z-Wave Plus device of the Vitrum 2.0 product range. Visit our website for the complete list.

This document is also available on our web-site.

Notice

Dispose cardboard box & holder, plastic bags and front plastic shell according to local recycling regulation. Box and holder are PAP recyclable, plastic bags are LDPE, front shell is PP.

Safety

Take care of your safety. Use only insulated tools and remove power from the mains circuit breakers before and during any installation activity.

Caution

This device is a permanently connected to the mains thus implies it is mandatory to have a readily accessible disconnect device (like a circuit breaker) incorporated in the general wiring of the building with at least 3mm separation between contacts.

Danger: Risk of electrocution

Device installation and maintenance must be carried out by trained and skilled electricians in accordance with local wiring and building regulations. The device has no basic insulation and must never be used without the front glass plate. It must be installed in a way that protect from accidental contact. During installation procedure, the dummy plastic cover must be left on.

Before and during installation disconnect mains power.

Before you start

You will need available and ready to use:

- Small Phillips isolated screw driver
- Small slotted isolated driver (alternate)

Package content

- 1 x Din Rail mountable device

Preparation

Remove carefully the device from the cardboard support. Keep this manual for further reference.

Features

Touch operated button with RGB back-light.
 Based on Z-Wave[®] 500 module for wider coverage and higher data rate.
 Very low power consumption in standby.
 Easy installation.
 Acoustic feedback at button press.
 Over-the-air firmware update.

Z-WAVE NETWORKING

This product can be included and operates in any Z-Wave network with other Z-Wave certified devices from other manufacturers and/or other applications. This device is an always powered node and within the network will act as repeater regardless of vendor to increase reliability of the network.

ADD (inclusion)

The device supports both Normal Inclusion and Network Wide Inclusion.

Follow the steps below to include the device into the network:

1. Check the device is not already included in a Z-Wave network by pressing the z-wave button [1] on the front panel: the LED on the button's circle should blink red shortly. If the LED blinks green the device is already included, follow the instructions below to exclude it from the network.
2. Set the controller into "Inclusion Mode". Refer to the controller documentation to set the controller into Inclusion mode.
3. Set the device into Learn Mode by pressing and holding the z-wave button [1] for longer than 4 seconds. The device will enter into inclusion mode by blinking magenta the button LED. Upon successful completion, the button LEDs of the device will blink green three times.
4. Should for any reasons the device fail the normal inclusion, the device turns to enter into the Network Wide Inclusion Mode up to 4 times. Any time the device enters into Wide Inclusion Mode, LED of the z-wave button blinks Magenta.

REMOVE (exclusion)

Before starting to exclude the device from the network set the controller into "Exclusion Mode". Please refer to the controller documentation to set the controller into Exclusion mode.

The device can be excluded from a network only if previously included. Check that by pressing the z-wave button [1] on the front panel: the LED button should shortly blink with green colour.

Follow the steps below to exclude the device from the network:

1. Press and hold the z-wave button [1] until the button LED blinks magenta and after that press 3 times the same button within 3 seconds.
2. The LED Buttons blink red upon completely the device exclusion successfully.
3. Check the device is removed from the network by pressing the z-wave button [1] its LED button blinks red shortly.

Node Info Frame

Follow the steps below to send a Node Info Frame:

1. Press shortly the radio button (first button on the left). After pressing it there will be a short audio signal (*beep*), within the radio Node Info
2. Go to *menu* to send a multichannel capability report

Firmware Update

This device supports the firmware update which can be started from any certified Z-Wave controller supporting the Firmware Update Command Class version 3 and above. While updating the device works normally. Just when the firmware update completes, the device will be inactive for few seconds during self-programming and rebooting.

During the reboot process, the local loads (if present) will be disengaged. Should the firmware update fail, the whole updating process must be restarted from the beginning.

The updating will last from 10 to 30 minutes depending on the network traffic condition.

Factory Default procedure

1. Press and hold the SELECT button [...] to enter the menu. The button LED will blink in white, keep pressing until the device will beep 3 times and the button LED will turn steady white. (**except the model EU 3M**)
2. Press again the SELECT button [...] until the button LED will turns red.
3. Press the SET button [v] till the buzzer plays a long beep (5 s).
4. Release the button and press it again till the buzzer plays a sequence of 3 short beeps.

The device will revert to its factory default settings, blinking all LED buttons and rebooting.

Do not disconnect the device from the power supply until reboot is completed.

Configuration and settings are restored to default values. "Home ID" and "Node ID" will be cleared as well.

ASSOCIATION/MULTICHANNEL ASSOCIATION

Association enables the device to control other nodes included in the same Z-Wave network for a maximum of **20 nodes** for **each button/group** with max **10 endpoints per Node**.

Group 1 Lifeline Notification

Max 20 associations available, Singlechannel or Multichannel.

Warning: In order to enable a controller to receive notifications with a endpoint source address from a Multichannel device, the controller must be associated to the lifeline group with the Multichannel association command class.

Example: if controller Node ID is 1, MULTICHANNEL ASSOCIATION must be set to the lifeline group 1 with controller nodeID(1) and endpoint(1)

Group 2 Reserved

Group 3 MAX_NODES_IN_GROUP 20

MAX_END_POINTS per Node: 10

Single channel association is only for root device so if used in a Multichannel environment the source and destination endpoint are lost.

Multichannel Association instead contains the Source Endpoint and the Destination Endpoint so the device is addressed correctly.

General Rule for Groups

Each button has a dedicated group starting from #3 so button #1 is referred to **Group 3**, button #2 will control all the devices associated into group number 4 and so on. The number of groups depends on the number of endpoints (buttons). See table below for group association to buttons.

Messages sent by each group to associated devices are related to the "configuration type" of the endpoints.

Group N.	Button N.	Notes
1	-	Lifeline
2	-	Reserved
3	1	Always present
4	2	If present
5	3	If present
6	4	If present
7	5	If present
8	6	If present

PARAMETERS LIST

All parameters depends on their SIZE value. Size can be different from the table below. Before placing a "parameter #, SET value", always ask for a "Parameter #, GET" to retrieve the correct SIZE dimension.

See table below for the complete list of Configuration command Class parameters for all Vitrum products.

Description	Par. N. (Dec)	Size (B)	Value range	Default value
EP Type Button				
EP Type Button N.1 to N.6	1 to 6	1	0-26	Depends on specific device
End Point Type values				
EP_OFF		0		
EP_DIMMER		1	CC SWITCH MULTILEVEL - see par 31 to 36	
EP_SWITCHBUTTON		2	CC BASIC - see par 31 to 36	
EP_PUSHBUTTON		3	CC BASIC - see par 31 to 36	
EP_CURTAIN_1 Button		4	motor control with 1 button	
EP_CURTAIN		5	motor control with 2 buttons	
EP_MASTER_OFF		15	TBC	
EP_CURTAIN_UP		27	motor only up	
EP_CURTAIN_DOWN		28	motor only down	
Button Off Color				
Button N.1 to N.6 Off Color status	7 to 12	1	0-7	3
Button On Color				

Description	Par. N. (Dec)	Size (B)	Value range	Default value
Button N.1 to N.6 On Color status	13 to 18	1	0-7	4
Button Eco Color				
Button N.1 to N.6 Eco Color status	19 to 24	1	0-7	2
Button On/Off/Eco Color values list				
LED_COLOR_OFF	0			
LED_COLOR_RED	1			
LED_COLOR_GREEN	2			
LED_COLOR_BLU	3			
LED_COLOR_YELLOW	4			
LED_COLOR_MAGENTA	5			
LED_COLOR_CYAN	6			
LED_COLOR_WHITE	7			

Button to Output Port connection

Output Port connected to Button N.1 to N.6	25 to 30	1	0-6	
Output Port				
Not connected to any port	0			
Output Port N.1 to N.6 connected to button	1 to 6			
Basic or Multilevel SET max value type	31 to 36	1	0 = 0x63 (100%) 1 = 0xFF (last level)	0: 0x63

Motors Control Time

Channel 0 to 2 Motor Control Time (s)	191 to 193	1		60 (60 s)
Channel 0 Motor Control Switch All behavior (*1)	194	1		0
Channel 1 Motor Control Switch All behavior	195	1		0
Channel 2 Motor Control Switch All behavior	196	1		0
Lifeline queue time delay: <i>Add some delay to lifeline notifications</i>	215	2	1= 10 mS 10=100 mS 100=1000 mS	
NWI Enable	216	1	1: NWI enabled, default 0: learn mode classic only	
Multichannel Capability Report notification: Endpoint presentation after multichannel transmission	217	1	0: disabled, default 1: low power 2: Full Power	
Keyboard Lock Outputs and back-light still working 1. Lifeline notification CCConfig[218, 1] If a locked button is pressed 2. Force unlock: triple press on button 1 as per inclusion process -> BIP... BIP-BIP	218	1	0: unlock 1: lock	0: unlock
Triac safe mode when an EP is transformed in to curtain the corresponding Triac is disabled (only for triac dev.)	221	1	0:unable 1:disable	N/A

Example of End Point Type values:

Button configured as EP_CENTRAL_SCENE. It sends through the Lifeline association group the "Central Scene Notification" commands. (CMD_Key_Pressed,CMD_Key_Released,CMD_Key_Held_Down). To set an EP_CENTRAL_SCENE use the Configuration command Class parameter 1->6, value 0x1A.

NODE CAPABILITIES

Basic, Generic and Specific Device Class

Informations below Reported from Node Information Frame (NIF)

NIF PARAMETER DESCRIPTOR	LIBRARY IDENTIFIER
Basic Device Class	BASIC_TYPE_ROUTING_SLAVE Routing Slave Enhanced 232
Generic Device Class	GENERIC_TYPE_SWITCH_BINARY
Specific Device Class	SPECIFIC_TYPE_POWER_SWITCH_BINARY

Command Classes

Informations below Reported from:

- Node Information Frame (NIF)
- Version CC, Version Get and Report commands

COMMAND CLASS	LIBRARY IDENTIFIER	VERSION
Z-Wave Plus Info	COMMAND_CLASS_ZWAVEPLUS_INFO	2
Version	COMMAND_CLASS_VERSION	2
Manufacturer Specific	COMMAND_CLASS_MANUFACTURER_SPECIFIC	2
Device Reset Locally	COMMAND_CLASS_DEVICE_RESET_LOCALLY	1
Powerlevel	COMMAND_CLASS_POWERLEVEL	1
Firmware Update Meta Data	COMMAND_CLASS_FIRMWARE_UPDATE_MD	4
Association	COMMAND_CLASS_ASSOCIATION	2
Multi Channel Association	COMMAND_CLASS_MULTI_CHANNEL_ASSOCIATION	3
AGI (Association Gorup Info)	COMMAND_CLASS_ASSOCIATION_GRP_INFO	1
Multi Channel	COMMAND_CLASS_MULTI_CHANNEL	4
Configuration	COMMAND_CLASS_CONFIGURATION	1
Manufacturer Proprietary	COMMAND_CLASS_MANUFACTURER_PROPRIETARY	1
Indicator	COMMAND_CLASS_INDICATOR	1
Node Name and Location	COMMAND_CLASS_NODE_NAMING	1
All Switch	COMMAND_CLASS_SWITCH_ALL	1

COMMAND CLASS MARK

Scene Activation	COMMAND_CLASS_SCENE_ACTIVATION	1
Central Scene	COMMAND_CLASS_CENTRAL_SCENE	1
Multilevel Switch	COMMAND_CLASS_SWITCH_MULTILEVEL	4
Binary Switch	COMMAND_CLASS_SWITCH_BINARY	1
Basic	COMMAND_CLASS_BASIC	1

Command Class Specification

COMMAND CLASS BASIC SET: MAX Value = [0x63 o 0xFF] -> [par31->36]
COMMAND CLASS INDICATOR values 0-7,0xFF

The version implemented is the #1 and may turn the device as a blinking indicator. The supported values are 0x00 (off/disable) or 0xFF (on/enable) and the field may carry valid values from 1 to 7.

0xFF: StartBlink(ALL_CHANNELS, YELLOW);
0x00: StopBlink(ALL_CHANNELS);

Valid values are:

1: white, 2: blue, 3: green, 4: cyan, 5: red, 6: magenta, 7: yellow

Timeout: ~60s

Generic and Specific Device Class by Curtain Endpoint

Informations below reported from Multi Channel Capability Report Command, valid if endpoint is set as "CURTAIN" only.

PARAMETER DESCRIPTOR	DESCRIPTION	LIBRARY IDENTIFIER
Generic Device Class	Switch Multilevel	GENERIC_TYPE_SWITCH_MULTILEVEL
Specific Device Class	Class A Motor Control	SPECIFIC_TYPE_CLASS_A_MOTOR_CONTROL

SUPPORTED COMMAND CLASS BY ENDPOINT

Informations below reported from Multi Channel Capability Report Command:

COMMAND CLASS	LIBRARY IDENTIFIER	VERSION
Binary	COMMAND_CLASS_SWITCH_BINARY	1
Multilevel Switch	COMMAND_CLASS_SWITCH_MULTILEVEL	4

DYNAMIC ENDPOINT EXPLANATION

Endpoints 1, 2, 3, set as "CURTAIN", are linked with endpoints 4, 5, 6 in vertical pairs, so endpoint 1 (direction up) is linked to endpoint 4 (direction down), and so on. Therefore endpoint 4, 5, 6, will not be "INTEROPERABLE" if a multichannel capability get is requested.

The valid endpoint association groups will be only 3, 4, 5. Relevant parameters are 191-196.

SPECIFICATIONS

Manufacturer ID: 0x010A

Models and Frequencies

REGION	CODE	FREQUENCY	PRODUCT TYPE ID	PRODUCT ID	APP ID
EU	01D02H010	868.4 Mhz	0x7115	0x1016	0x0215
IL	01DE20010	916 Mhz	0x7006	0x0F07	0x0106
KR	01DB2H010	921.4 Mhz	0x7116	0x1017	0x0216

Technical Specifications

Operating voltage	230 VAC 50 Hz
Consumption	<1.5W standby
Operating temperature	from 0°C to +40°C
Operating Humidity	20% - 90% RH non condensing
Storage temperature	from -40°C to +55°C
Storage Humidity	10% - 93% RH non condensing
IP Class	IP20
Package Dimension (W x H x D)	110 x 72 x 62 mm
Weight	~210 gr
RF radiated powered	2.5 mW (max)
RF range	Up to 40 m open range
Warranty	1 year

INSTALLATION

Wire the device according to the schematic below.

L Power connection (LIVE)
N Power connection (Neutral)

Position the device in the wall's mounting box and check cables are not interfering with the device case. Using the appropriate screw set that matches the wall box, fix the device in place without applying unnecessary torque to fixing screws.

Choosing a suitable location

Do not locate the device facing direct sunlight, humid or dusty place. The suitable ambient temperature is listed in specification.

Do not locate the device where there are any combustible substances or sources of heat (e.g. fires, radiators, boiler, etc.).

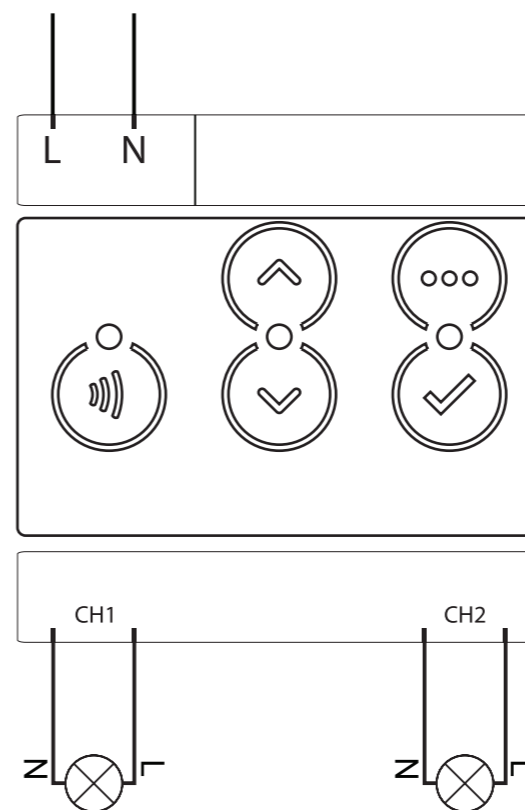

FUNCTIONS

Buttons and LEDs are numbered according to the picture below facing front the device.

Each button has an RGB back-light LED that shows different colours during normal operation and certain sequence are also used to report special status.

Button #1 is used as **z-wave network button**

USABILITY

For actives the Din Rail Module by Vitrum Design follow the instructions Press the Menu key (# 3) for 4 seconds, use the direction keys (# 2 and # 4) to select the desired channel and press the selection key (# 5) to switch the selected relay or dimmer. To exit the menu, hold down the Menu key (# 3) for 4 seconds or after 30 seconds of inactivity, the device automatically exits the selection menu.

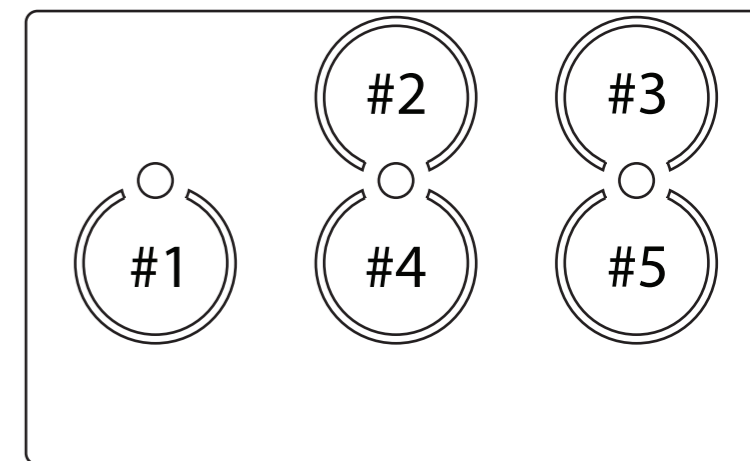

Special condition or status

LED	Colour codes	Description
LED #1	<i>blinks green for 5s</i>	<i>Valid HW signature detected at boot</i>
	<i>blinks red for 5s</i>	<i>Invalid HW signature detected at boot</i>
	<i>red glitch</i>	<i>When button #1 is touched indicates device is NOT included in the Z-Wave network</i>
	<i>Steady red</i>	<i>HW fault, contact assistance</i>

Normal operating condition or status

LED	Colour codes	Description
Any LED	<i>Steady blue</i>	<i>BASIC off or MULTILEVEL 0%</i>
	<i>Steady green</i>	<i>light dimming MULTILEVEL set at 33%</i>
	<i>Steady yellow</i>	<i>MULTILEVEL set at 100% or BASIC on</i>
	<i>Steady magenta</i>	<i>MOTOR control</i>

STANDARDS AND REGULATIONS

Electrical safety	(LVD) 2014/35/EU
Electromagnetic compatibility	(EMC) 2014/30/EU
Radio	(RED) 2014/53/EU
Presence of hazardous substances	(RoHS II) 2011/65/EU
Waste electrical and electronic equipment	(WEEE) 2012/19/EU

List of harmonized regulations applied

EN 301 489-1 V1.9.2; EN 301 489-3 V1.6.1
EN 50491-5-1:2010; EN 50491-5-2:2010
EN 60669-1:2000; EN 60669-1/A1:2003; EN60669-1/A2:2009
EN 60669-2-1:2004; EN 60669-2-1/A1:2009; EN 60669-2-1/A12:2009
EN 62479: 2010
EN 300 220-2 V.2.4.1



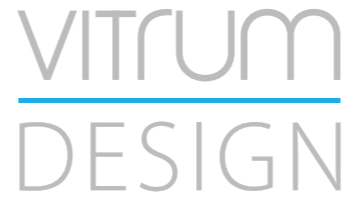

Model: RailZ-4M
Type: HVAC - 3S2V
Code: 02A00H050
Protocol: Z-Wave Plus

INTRODUCTION

Purpose of this document

This manual describes the most essential functions and technical specifications to help the electrician to install, setup and control the device. It is a Z-Wave Plus device of the Vitrum 2.0 product range. Visit our website for the complete list.

This document is also available on our web-site.

Notice

Dispose cardboard box & holder, plastic bags and front plastic shell according to local recycling regulation. Box and holder are PAP recyclable, plastic bags are LDPE, front shell is PP.

Safety

Take care of your safety. Use only insulated tools and remove power from the mains circuit breakers before and during any installation activity.

Caution

This device is a permanently connected to the mains thus implies it is mandatory to have a readily accessible disconnect device (like a circuit breaker) incorporated in the general wiring of the building with at least 3mm separation between contacts.

Danger: Risk of electrocution

Device installation and maintenance must be carried out by trained and skilled electricians in accordance with local wiring and building regulations. The device has no basic insulation and must never be used without the front glass plate. It must be installed in a way that protect from accidental contact. During installation procedure, the dummy plastic cover must be left on.

Before and during installation disconnect mains power.

Before you start

You will need available and ready to use:

- Small Phillips isolated screw driver
- Small slotted isolated driver (alternate)

Package content

- 1 x Din Rail mountable device

Preparation

Remove carefully the device from the cardboard support. Keep this manual for further reference.

Features

Touch operated button with RGB back-light.
 Based on Z-Wave[®] 500 module for wider coverage and higher data rate.
 Very low power consumption in standby.
 Easy installation.
 Acoustic feedback at button press.
 Over-the-air firmware update.

Z-WAVE NETWORKING

This product can be included and operates in any Z-Wave network with other Z-Wave certified devices from other manufacturers and/or other applications. This device is an always powered node and within the network will act as repeater regardless of vendor to increase reliability of the network.

ADD (inclusion)

The device supports both Normal Inclusion and Network Wide Inclusion.

Follow the steps below to include the device into the network:

1. Check the device is not already included in a Z-Wave network by pressing the z-wave button [1] on the front panel: the LED on the button's circle should blink red shortly. If the LED blinks green the device is already included, follow the instructions below to exclude it from the network.
2. Set the controller into "Inclusion Mode". Refer to the controller documentation to set the controller into Inclusion mode.
3. Set the device into Learn Mode by pressing and holding the z-wave button [1] for longer than 4 seconds. The device will enter into inclusion mode by blinking magenta the button LED. Upon successful completion, the button LEDs of the device will blink green three times.
4. Should for any reasons the device fail the normal inclusion, the device turns to enter into the Network Wide Inclusion Mode up to 4 times. Any time the device enters into Wide Inclusion Mode, LED of the z-wave button blinks Magenta.

REMOVE (exclusion)

Before starting to exclude the device from the network set the controller into "Exclusion Mode". Please refer to the controller documentation to set the controller into Exclusion mode.

The device can be excluded from a network only if previously included. Check that by pressing the z-wave button [1] on the front panel: the LED button should shortly blink with green colour.

Follow the steps below to exclude the device from the network:

1. Press and hold the z-wave button [1] until the button LED blinks magenta and after that press 3 times the same button within 3 seconds.
2. The LED Buttons blink red upon completely the device exclusion successfully.
3. Check the device is removed from the network by pressing the z-wave button [1] its LED button blinks red shortly.

Node Info Frame

Follow the steps below to send a Node Info Frame:

1. Press shortly the radio button (first button on the left). After pressing it there will be a short audio signal (*beep*), within the radio Node Info
2. Go to *menu* to send a multichannel capability report

Firmware Update

This device supports the firmware update which can be started from any certified Z-Wave controller supporting the Firmware Update Command Class version 3 and above. While updating the device works normally. Just when the firmware update completes, the device will be inactive for few seconds during self-programming and rebooting.

During the reboot process, the local loads (if present) will be disengaged. Should the firmware update fail, the whole updating process must be restarted from the beginning.

The updating will last from 10 to 30 minutes depending on the network traffic condition.

Factory Default procedure

1. Press and hold the SELECT button [...] to enter the menu. The button LED will blink in white, keep pressing until the device will beep 3 times and the button LED will turn steady white. (**except the model EU 3M**)
2. Press again the SELECT button [...] until the button LED will turns red.
3. Press the SET button [v] till the buzzer plays a long beep (5 s).
4. Release the button and press it again till the buzzer plays a sequence of 3 short beeps.

The device will revert to its factory default settings, blinking all LED buttons and rebooting.

Do not disconnect the device from the power supply until reboot is completed.

Configuration and settings are restored to default values. "Home ID" and "Node ID" will be cleared as well.

ASSOCIATION/MULTICHANNEL ASSOCIATION

Association enables the device to control other nodes included in the same Z-Wave network for a maximum of **20 nodes** for **each button/group** with max **10 endpoints per Node**.

Group 1 Lifeline Notification

Max 20 associations available, Singlechannel or Multichannel.

Warning: In order to enable a controller to receive notifications with a endpoint source address from a Multichannel device, the controller must be associated to the lifeline group with the Multichannel association command class.

Example: if controller Node ID is 1, MULTICHANNEL ASSOCIATION must be set to the lifeline group 1 with controller nodeID(1) and endpoint(1)

Group 2 Reserved

Group 3 MAX_NODES_IN_GROUP 20

MAX_END_POINTS per Node: 10

Single channel association is only for root device so if used in a Multichannel environment the source and destination endpoint are lost.

Multichannel Association instead contains the Source Endpoint and the Destination Endpoint so the device is addressed correctly.

General Rule for Groups

Each button has a dedicated group starting from #3 so button #1 is referred to **Group 3**, button #2 will control all the devices associated into group number 4 and so on. The number of groups depends on the number of endpoints (buttons). See table below for group association to buttons.

Messages sent by each group to associated devices are related to the "configuration type" of the endpoints.

Group N.	Button N.	Notes
1	-	Lifeline
2	-	Reserved
3	1	Always present
4	2	If present
5	3	If present
6	4	If present
7	5	If present
8	6	If present

PARAMETERS LIST

All parameters depends on their SIZE value. Size can be different from the table below. Before placing a "parameter #, SET value", always ask for a "Parameter #, GET" to retrieve the correct SIZE dimension.

See table below for the complete list of Configuration command Class parameters for all Vitrum products.

Description	Par. N. (Dec)	Size (B)	Value range	Default value
EP Type Button				
EP Type Button N.1 to N.6	1 to 6	1	0-26	Depends on specific device
End Point Type values				
EP_OFF			0	
EP_DIMMER			1 CC SWITCH MULTILEVEL - see par 31 to 36	
EP_SWITCHBUTTON			2 CC BASIC - see par 31 to 36	
EP_PUSHBUTTON			3 CC BASIC - see par 31 to 36	
EP_CURTAIN_1 Button			4 motor control with 1 button	
EP_CURTAIN			5 motor control with 2 buttons	
EP_MASTER_OFF			15 TBC	
EP_CURTAIN_UP			27 motor only up	
EP_CURTAIN_DOWN			28 motor only down	
Button Off Color				
Button N.1 to N.6 Off Color status	7 to 12	1	0-7	3
Button On Color				

Description	Par. N. (Dec)	Size (B)	Value range	Default value
Button N.1 to N.6 On Color status	13 to 18	1	0-7	4
Button Eco Color				
Button N.1 to N.6 Eco Color status	19 to 24	1	0-7	2
Button On/Off/Eco Color values list				
LED_COLOR_OFF	0			
LED_COLOR_RED	1			
LED_COLOR_GREEN	2			
LED_COLOR_BLU	3			
LED_COLOR_YELLOW	4			
LED_COLOR_MAGENTA	5			
LED_COLOR_CYAN	6			
LED_COLOR_WHITE	7			

Button to Output Port connection

Output Port connected to Button N.1 to N.6	25 to 30	1	0-6	
Output Port				
Not connected to any port	0			
Output Port N.1 to N.6 connected to button	1 to 6			
Basic or Multilevel SET max value type	31 to 36	1	0 = 0x63 (100%) 1 = 0xFF (last level)	0: 0x63

Motors Control Time

Channel 0 to 2 Motor Control Time (s)	191 to 193	1		60 (60 s)
Channel 0 Motor Control Switch All behavior (*1)	194	1		0
Channel 1 Motor Control Switch All behavior	195	1		0
Channel 2 Motor Control Switch All behavior	196	1		0
Lifeline queue time delay: <i>Add some delay to lifeline notifications</i>	215	2	1= 10 mS 10=100 mS 100=1000 mS	
NWI Enable	216	1	1: NWI enabled, default 0: learn mode classic only	
Multichannel Capability Report notification: Endpoint presentation after multichannel transmission	217	1	0: disabled, default 1: low power 2: Full Power	
Keyboard Lock Outputs and back-light still working 1. Lifeline notification CCConfig[218, 1] If a locked button is pressed 2. Force unlock: triple press on button 1 as per inclusion process -> BIP... BIP-BIP	218	1	0: unlock 1: lock	0: unlock
Triac safe mode when an EP is transformed in to curtain the corresponding Triac is disabled (only for triac dev.)	221	1	0:unable 1:disable	N/A

Example of End Point Type values:

Button configured as EP_CENTRAL_SCENE. It sends through the Lifeline association group the "Central Scene Notification" commands. (CMD_Key_Pressed, CMD_Key_Released, CMD_Key_Held_Down).

To set an EP_CENTRAL_SCENE use the Configuration command Class parameter 1->6, value 0x1A.

NODE CAPABILITIES

Basic, Generic and Specific Device Class

Informations below Reported from Node Information Frame (NIF)

NIF PARAMETER DESCRIPTOR	LIBRARY IDENTIFIER
Basic Device Class	BASIC_TYPE_ROUTING_SLAVE Routing Slave Enhanced 232
Generic Device Class	GENERIC_TYPE_SWITCH_BINARY
Specific Device Class	SPECIFIC_TYPE_POWER_SWITCH_BINARY

Command Classes

Informations below Reported from:

- Node Information Frame (NIF)
- Version CC, Version Get and Report commands

COMMAND CLASS	LIBRARY IDENTIFIER	VERSION
Z-Wave Plus Info	COMMAND_CLASS_ZWAVEPLUS_INFO	2
Version	COMMAND_CLASS_VERSION	2
Manufacturer Specific	COMMAND_CLASS_MANUFACTURER_SPECIFIC	2
Device Reset Locally	COMMAND_CLASS_DEVICE_RESET_LOCALLY	1
Powerlevel	COMMAND_CLASS_POWERLEVEL	1
Firmware Update Meta Data	COMMAND_CLASS_FIRMWARE_UPDATE_MD	4
Association	COMMAND_CLASS_ASSOCIATION	2
Multi Channel Association	COMMAND_CLASS_MULTI_CHANNEL_ASSOCIATION	3
AGI (Association Gorup Info)	COMMAND_CLASS_ASSOCIATION_GRP_INFO	1
Multi Channel	COMMAND_CLASS_MULTI_CHANNEL	4
Configuration	COMMAND_CLASS_CONFIGURATION	1
Manufacturer Proprietary	COMMAND_CLASS_MANUFACTURER_PROPRIETARY	1
Indicator	COMMAND_CLASS_INDICATOR	1
Node Name and Location	COMMAND_CLASS_NODE_NAMING	1
All Switch	COMMAND_CLASS_SWITCH_ALL	1
COMMAND CLASS MARK		
Scene Activation	COMMAND_CLASS_SCENE_ACTIVATION	1
Central Scene	COMMAND_CLASS_CENTRAL_SCENE	1
Multilevel Switch	COMMAND_CLASS_SWITCH_MULTILEVEL	4
Binary Switch	COMMAND_CLASS_SWITCH_BINARY	1
Basic	COMMAND_CLASS_BASIC	1

Command Class Specification

COMMAND CLASS BASIC SET: MAX Value = [0x63 o 0xFF] -> [par31->36]

COMMAND CLASS INDICATOR values 0-7, 0xFF

The version implemented is the #1 and may turn the device as a blinking indicator. The supported values are 0x00 (off/disable) or 0xFF (on/enable) and the field may carry valid values from 1 to 7.

0xFF: StartBlink(ALL_CHANNELS, YELLOW);
0x00: StopBlink(ALL_CHANNELS);

Valid values are:

1: white, 2: blue, 3: green, 4: cyan, 5: red, 6: magenta, 7: yellow

Timeout: ~60s

Generic and Specific Device Class by Curtain Endpoint

Informations below reported from Multi Channel Capability Report Command, valid if endpoint is set as "CURTAIN" only.

PARAMETER DESCRIPTOR	DESCRIPTION	LIBRARY IDENTIFIER
Generic Device Class	Switch Multilevel	GENERIC_TYPE_SWITCH_MULTILEVEL
Specific Device Class	Class A Motor Control	SPECIFIC_TYPE_CLASS_A_MOTOR_CONTROL

SUPPORTED COMMAND CLASS BY ENDPOINT

Informations below reported from Multi Channel Capability Report Command:

COMMAND CLASS	LIBRARY IDENTIFIER	VERSION
Binary	COMMAND_CLASS_SWITCH_BINARY	1
Multilevel Switch	COMMAND_CLASS_SWITCH_MULTILEVEL	4

DYNAMIC ENDPOINT EXPLANATION

Endpoints 1, 2, 3, set as "CURTAIN", are linked with endpoints 4, 5, 6 in vertical pairs, so endpoint 1 (direction up) is linked to endpoint 4 (direction down), and so on. Therefore endpoint 4, 5, 6, will not be "INTEROPERABLE" if a multichannel capability get is requested.

The valid endpoint association groups will be only 3, 4, 5. Relevant parameters are 191-196.

SPECIFICATIONS

Manufacturer ID: 0x010A

Models and Frequencies

REGION	CODE	FREQUENCY	PRODUCT TYPE ID	PRODUCT ID	APP ID
EU	02A00H050	868.4 Mhz	0x7115	0x1016	0x0215
IL	02AE00050	916 Mhz	0x7006	0x0F07	0x0106
KR	02AB0H050	921.4 Mhz	0x7116	0x1017	0x0216

Technical Specifications

Operating voltage	230 VAC 50 Hz
Consumption	<1.5W standby
Operating temperature	from 0°C to +40°C
Operating Humidity	20% - 90% RH non condensing
Storage temperature	from -40°C to +55°C
Storage Humidity	10% - 93% RH non condensing
IP Class	IP20
Package Dimension (W x H x D)	110 x 72 x 62 mm
Weight	~210 gr
RF radiated powered	2.5 mW (max)
RF range	Up to 40 m open range
Warranty	1 year

INSTALLATION

Wire the device according to the schematic below.

L Power connection (LIVE)
N Power connection (Neutral)

Position the device in the wall's mounting box and check cables are not interfering with the device case. Using the appropriate screw set that matches the wall box, fix the device in place without applying unnecessary torque to fixing screws.

Choosing a suitable location

Do not locate the device facing direct sunlight, humid or dusty place. The suitable ambient temperature is listed in specification.

Do not locate the device where there are any combustible substances or sources of heat (e.g. fires, radiators, boiler, etc.).

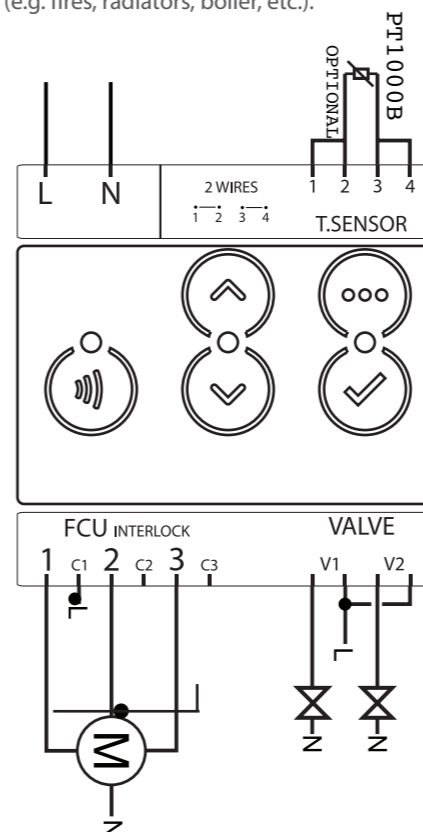

FUNCTIONS

Buttons and LEDs are numbered according to the picture below facing front the device.

Each button has an RGB back-light LED that shows different colours during normal operation and certain sequence are also used to report special status.

Button #1 is used as **z-wave network button**

USABILITY

For activates the Din Rail Module by Vitrum Design follow the instructions Press the Menu key (# 3) for 4 seconds, use the direction keys (# 2 and # 4) to select the desired channel and press the selection key (# 5) to switch the selected relay or dimmer. To exit the menu, hold down the Menu key (# 3) for 4 seconds or after 30 seconds of inactivity, the device automatically exits the selection menu.

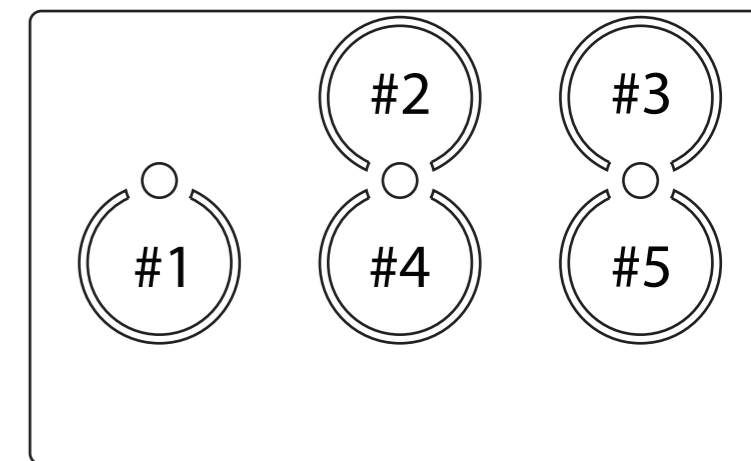

Special condition or status

LED	Colour codes	Description
LED #1	<i>blinks green for 5s</i>	<i>Valid HW signature detected at boot</i>
	<i>blinks red for 5s</i>	<i>Invalid HW signature detected at boot</i>
	<i>red glitch</i>	<i>When button #1 is touched indicates device is NOT included in the Z-Wave network</i>
	<i>Steady red</i>	<i>HW fault, contact assistance</i>

Normal operating condition or status

LED	Colour codes	Description
Any LED	<i>Steady blue</i>	<i>BASIC off or MULTILEVEL 0%</i>
	<i>Steady green</i>	<i>light dimming MULTILEVEL set at 33%</i>
	<i>Steady yellow</i>	<i>MULTILEVEL set at 100% or BASIC on</i>
	<i>Steady magenta</i>	<i>MOTOR control</i>

STANDARDS AND REGULATIONS

Electrical safety	(LVD) 2014/35/EU
Electromagnetic compatibility	(EMC) 2014/30/EU
Radio	(RED) 2014/53/EU
Presence of hazardous substances	(RoHS II) 2011/65/EU
Waste electrical and electronic equipment	(WEEE) 2012/19/EU

List of harmonized regulations applied

EN 301 489-1 V1.9.2; EN 301 489-3 V1.6.1
EN 50491-5-1:2010; EN 50491-5-2:2010
EN 60669-1:2000; EN 60669-1/A1:2003; EN60669-1/A2:2009
EN 60669-2-1:2004; EN 60669-2-1/A1:2009; EN 60669-2-1/A12:2009
EN 62479: 2010
EN 300 220-2 V.2.4.1



Vitrum DIN IV Double Shutter Cloud



Model: RailZ-4M
Type: Motor-2CH
Code: 01D04H030
Protocol: Z-Wave Plus

INTRODUCTION

Purpose of this document

This manual describes the most essential functions and technical specifications to help the electrician to install, setup and control the device. It is a Z-Wave Plus device of the Vitrum 2.0 product range. Visit our website for the complete list.

This document is also available on our web-site.

Notice

Dispose cardboard box & holder, plastic bags and front plastic shell according to local recycling regulation. Box and holder are PAP recyclable, plastic bags are LDPE, front shell is PP.

Safety

Take care of your safety. Use only insulated tools and remove power from the mains circuit breakers before and during any installation activity.

Caution

This device is a permanently connected to the mains thus implies it is mandatory to have a readily accessible disconnect device (like a circuit breaker) incorporated in the general wiring of the building with at least 3mm separation between contacts.

Danger: Risk of electrocution

Device installation and maintenance must be carried out by trained and skilled electricians in accordance with local wiring and building regulations. The device has no basic insulation and must never be used without the front glass plate. It must be installed in a way that protect from accidental contact. During installation procedure, the dummy plastic cover must be left on.

Before and during installation disconnect mains power.

Before you start

- You will need available and ready to use:
- Small Phillips isolated screw driver
 - Small slotted isolated driver (alternate)

Package content

- 1 x Din Rail mountable device

Preparation

Remove carefully the device from the cardboard support. Keep this manual for further reference.

Features

Touch operated button with RGB back-light.
 Based on Z-Wave[®] 500 module for wider coverage and higher data rate.
 Very low power consumption in standby.
 Easy installation.
 Acoustic feedback at button press.
 Over-the-air firmware update.

Z-WAVE NETWORKING

This product can be included and operates in any Z-Wave network with other Z-Wave certified devices from other manufacturers and/or other applications. This device is an always powered node and within the network will act as repeater regardless of vendor to increase reliability of the network.

ADD (inclusion)

The device supports both Normal Inclusion and Network Wide Inclusion.

Follow the steps below to include the device into the network:

1. Check the device is not already included in a Z-Wave network by pressing the z-wave button [1] on the front panel: the LED on the button's circle should blink red shortly. If the LED blinks green the device is already included, follow the instructions below to exclude it from the network.
2. Set the controller into "Inclusion Mode". Refer to the controller documentation to set the controller into Inclusion mode.
3. Set the device into Learn Mode by pressing and holding the z-wave button [1] for longer than 4 seconds. The device will enter into inclusion mode by blinking magenta the button LED. Upon successful completion, the button LEDs of the device will blink green three times.
4. Should for any reasons the device fail the normal inclusion, the device turns to enter into the Network Wide Inclusion Mode up to 4 times. Any time the device enters into Wide Inclusion Mode, LED of the z-wave button blinks Magenta.

REMOVE (exclusion)

Before starting to exclude the device from the network set the controller into "Exclusion Mode". Please refer to the controller documentation to set the controller into Exclusion mode.

The device can be excluded from a network only if previously included. Check that by pressing the z-wave button [1] on the front panel: the LED button should shortly blink with green colour.

Follow the steps below to exclude the device from the network:

1. Press and hold the z-wave button [1] until the button LED blinks magenta and after that press 3 times the same button within 3 seconds.
2. The LED Buttons blink red upon completely the device exclusion successfully.
3. Check the device is removed from the network by pressing the z-wave button [1] its LED button blinks red shortly.

Node Info Frame

Follow the steps below to send a Node Info Frame:

1. Press shortly the radio button (first button on the left). After pressing it there will be a short audio signal (*beep*), within the radio Node Info
2. Go to *menu* to send a multichannel capability report

Firmware Update

This device supports the firmware update which can be started from any certified Z-Wave controller supporting the Firmware Update Command Class version 3 and above. While updating the device works normally. Just when the firmware update completes, the device will be inactive for few seconds during self-programming and rebooting.

During the reboot process, the local loads (if present) will be disengaged. Should the firmware update fail, the whole updating process must be restarted from the beginning.

The updating will last from 10 to 30 minutes depending on the network traffic condition.

Factory Default procedure

1. Press and hold the SELECT button [...] to enter the menu. The button LED will blink in white, keep pressing until the device will beep 3 times and the button LED will turn steady white. **(except the model EU 3M)**
2. Press again the SELECT button [...] until the button LED will turns red.
3. Press the SET button [v] till the buzzer plays a long beep (5 s).
4. Release the button and press it again till the buzzer plays a sequence of 3 short beeps.

The device will revert to its factory default settings, blinking all LED buttons and rebooting.

Do not disconnect the device from the power supply until reboot is completed.

Configuration and settings are restored to default values. "Home ID" and "Node ID" will be cleared as well.

ASSOCIATION/MULTICHANNEL ASSOCIATION

Association enables the device to control other nodes included in the same Z-Wave network for a maximum of **20 nodes** for **each button/group** with max **10 endpoints per Node**.

Group 1 Lifeline Notification

Max 20 associations available, Singlechannel or Multichannel.

Warning: In order to enable a controller to receive notifications with a

EP_OFF	0
EP_CURTAIN	5 MOTOR CONTROL WITH 2 BUTTONS

Group 2 Reserved

Group 3 MAX_NODES_IN_GROUP 20

MAX_END_POINTS per Node: 10

Single channel association is only for root device so if used in a Multichannel environment the source and destination endpoint are lost. Multichannel Association instead contains the Source Endpoint and the Destination Endpoint so the device is addressed correctly.

General Rule for Groups

Each button has a dedicated group starting from #3 so button #1 is referred to **Group 3**, button #2 will control all the devices associated into group number 4 and so on. The number of groups depends on the number of endpoints (buttons). See table below for group association to buttons.

Messages sent by each group to associated devices are related to the "configuration type" of the endpoints.

Group N.	Button N.	Notes
1	-	Lifeline
2	-	Reserved
3	1	Always present
4	2	If present
5	3	If present
6	4	If present
7	5	If present
8	6	If present

PARAMETERS LIST

All parameters depends on their SIZE value. Size can be different from the table below. Before placing a "parameter #, SET value", always ask for a "Parameter #, GET" to retrieve the correct SIZE dimension.

See table below for the complete list of Configuration command Class parameters for all Vitrum products.

Description	Par. N. (Dec)	Size (B)	Value range	Default value
EP Type Button				
EP Type Button N.1 to N.6	1 to 6	1	0-26	Depends on specific device
End Point Type values				
EP_OFF	0			
EP_DIMMER	1		CC SWITCH MULTILEVEL - see par 31 to 36	
EP_SWITCHBUTTON	2		CC BASIC - see par 31 to 36	
EP_PUSHBUTTON	3		CC BASIC - see par 31 to 36	
EP CURTAIN_1 Button	4		motor control with 1 button	
EP_CURTAIN	5		motor control with 2 buttons	
EP_MASTER_OFF	15		TBC	
EP CURTAIN_UP	27		motor only up	
EP CURTAIN_DOWN	28		motor only down	
Button Off Color				
Button N.1 to N.6 Off Color status	7 to 12	1	0-7	3
Button On Color				

Description	Par. N. (Dec)	Size (B)	Value range	Default value
Button N.1 to N.6 On Color status	13 to 18	1	0-7	4
Button Eco Color				
Button N.1 to N.6 Eco Color status	19 to 24	1	0-7	2
Button On/Off/Eco Color values list				
LED_COLOR_OFF	0			
LED_COLOR_RED	1			
LED_COLOR_GREEN	2			
LED_COLOR_BLU	3			
LED_COLOR_YELLOW	4			
LED_COLOR_MAGENTA	5			
LED_COLOR_CYAN	6			
LED_COLOR_WHITE	7			

Button to Output Port connection

Output Port connected to Button N.1 to N.6	25 to 30	1	0-6	
Output Port				
Not connected to any port	0			
Output Port N.1 to N.6 connected to button	1 to 6			
Basic or Multilevel SET max value type	31 to 36	1	0 = 0x63 (100%) 1 = 0xFF (last level)	0: 0x63

Motors Control Time

Channel 0 to 2 Motor Control Time (s)	191 to 193	1		60 (60 s)
Channel 0 Motor Control Switch All behavior (*1)	194	1		0
Channel 1 Motor Control Switch All behavior	195	1		0
Channel 2 Motor Control Switch All behavior	196	1		0
Lifeline queue time delay: <i>Add some delay to lifeline notifications</i>	215	2	1= 10 mS 10=100 mS 100=1000 mS	
NWI Enable	216	1	1: NWI enabled, default 0: learn mode classic only	
Multichannel Capability Report notification: Endpoint presentation after multichannel transmission	217	1	0: disabled, default 1: low power 2: Full Power	
Keyboard Lock Outputs and back-light still working 1. Lifeline notification CCConfig[218, 1] If a locked button is pressed 2. Force unlock: triple press on button 1 as per inclusion process -> BIP... BIP-BIP	218	1	0: unlock 1: lock	0: unlock
Triac safe mode when an EP is transformed in to curtain the corresponding Triac is disabled (only for triac dev.)	221	1	0:unable 1:disable	N/A

Example of End Point Type values:

Button configured as EP_CENTRAL_SCENE. It sends through the Lifeline association group the "Central Scene Notification" commands. (CMD_Key_Pressed,CMD_Key_Released,CMD_Key_Held_Down). To set an EP_CENTRAL_SCENE use the Configuration command Class parameter 1->6, value 0x1A.

NODE CAPABILITIES

Basic, Generic and Specific Device Class

Informations below Reported from Node Information Frame (NIF)

NIF PARAMETER DESCRIPTOR	LIBRARY IDENTIFIER
Basic Device Class	BASIC_TYPE_ROUTING_SLAVE Routing Slave Enhanced 232
Generic Device Class	GENERIC_TYPE_SWITCH_BINARY
Specific Device Class	SPECIFIC_TYPE_POWER_SWITCH_BINARY

Command Classes

Informations below Reported from:

- Node Information Frame (NIF)
- Version CC, Version Get and Report commands

COMMAND CLASS	LIBRARY IDENTIFIER	VERSION
Z-Wave Plus Info	COMMAND_CLASS_ZWAVEPLUS_INFO	2
Version	COMMAND_CLASS_VERSION	2
Manufacturer Specific	COMMAND_CLASS_MANUFACTURER_SPECIFIC	2
Device Reset Locally	COMMAND_CLASS_DEVICE_RESET_LOCALLY	1
Powerlevel	COMMAND_CLASS_POWERLEVEL	1
Firmware Update Meta Data	COMMAND_CLASS_FIRMWARE_UPDATE_MD	4
Association	COMMAND_CLASS_ASSOCIATION	2
Multi Channel Association	COMMAND_CLASS_MULTI_CHANNEL_ASSOCIATION	3
AGI (Association Gorup Info)	COMMAND_CLASS_ASSOCIATION_GRP_INFO	1
Multi Channel	COMMAND_CLASS_MULTI_CHANNEL	4
Configuration	COMMAND_CLASS_CONFIGURATION	1
Manufacturer Proprietary	COMMAND_CLASS_MANUFACTURER_PROPRIETARY	1
Indicator	COMMAND_CLASS_INDICATOR	1
Node Name and Location	COMMAND_CLASS_NODE_NAMING	1
All Switch	COMMAND_CLASS_SWITCH_ALL	1
COMMAND CLASS MARK		
Scene Activation	COMMAND_CLASS_SCENE_ACTIVATION	1
Central Scene	COMMAND_CLASS_CENTRAL_SCENE	1
Multilevel Switch	COMMAND_CLASS_SWITCH_MULTILEVEL	4
Binary Switch	COMMAND_CLASS_SWITCH_BINARY	1
Basic	COMMAND_CLASS_BASIC	1

Command Class Specification

COMMAND CLASS BASIC SET: MAX Value = [0x63 o 0xFF] -> [par31->36]
COMMAND CLASS INDICATOR values 0-7,0xFF

The version implemented is the #1 and may turn the device as a blinking indicator. The supported values are 0x00 (off/disable) or 0xFF (on/enable) and the field may carry valid values from 1 to 7.

0xFF: StartBlink(ALL_CHANNELS, YELLOW);
0x00: StopBlink(ALL_CHANNELS);

Valid values are:

1: white, 2: blue, 3: green, 4: cyan, 5: red, 6: magenta, 7: yellow

Timeout: ~60s

Generic and Specific Device Class by Curtain Endpoint

Informations below reported from Multi Channel Capability Report Command, valid if endpoint is set as "CURTAIN" only.

PARAMETER DESCRIPTOR	DESCRIPTION	LIBRARY IDENTIFIER
Generic Device Class	Switch Multilevel	GENERIC_TYPE_SWITCH_MULTILEVEL
Specific Device Class	Class A Motor Control	SPECIFIC_TYPE_CLASS_A_MOTOR_CONTROL

SUPPORTED COMMAND CLASS BY ENDPOINT

Informations below reported from Multi Channel Capability Report Command:

COMMAND CLASS	LIBRARY IDENTIFIER	VERSION
Binary	COMMAND_CLASS_SWITCH_BINARY	1
Multilevel Switch	COMMAND_CLASS_SWITCH_MULTILEVEL	4

DYNAMIC ENDPOINT EXPLANATION

Endpoints 1, 2, 3, set as "CURTAIN", are linked with endpoints 4, 5, 6 in vertical pairs, so endpoint 1 (direction up) is linked to endpoint 4 (direction down), and so on. Therefore endpoint 4, 5, 6, will not be "INTEROPERABLE" if a multichannel capability get is requested.

The valid endpoint association groups will be only 3, 4, 5. Relevant parameters are 191-196.

SPECIFICATIONS

Manufacturer ID: 0x010A

Models and Frequencies

REGION	CODE	FREQUENCY	PRODUCT TYPE ID	PRODUCT ID	APP ID
EU	01D04H030	868.4 Mhz	0x7115	0x1016	0x0215
IL	01DE40030	916 Mhz	0x7006	0x0F07	0x0106
KR	01DB4H030	921.4 Mhz	0x7116	0x1017	0x0216

Technical Specifications

Operating voltage	230 VAC 50 Hz
Consumption	<1.5W standby
Operating temperature	from 0°C to +40°C
Operating Humidity	20% - 90% RH non condensing
Storage temperature	from -40°C to +55°C
Storage Humidity	10% - 93% RH non condensing
IP Class	IP20
Package Dimension (W x H x D)	110 x 72 x 62 mm
Weight	~210 gr
RF radiated powered	2.5 mW (max)
RF range	Up to 40 m open range
Warranty	1 year

INSTALLATION

Wire the device according to the schematic below.

- L Power connection (LIVE)
- N Power connection (Neutral)

Position the device in the wall's mounting box and check cables are not interfering with the device case. Using the appropriate screw set that matches the wall box, fix the device in place without applying unnecessary torque to fixing screws.

Choosing a suitable location

Do not locate the device facing direct sunlight, humid or dusty place. The suitable ambient temperature is listed in specification.

Do not locate the device where there are any combustible substances or sources of heat (e.g. fires, radiators, boiler, etc.).

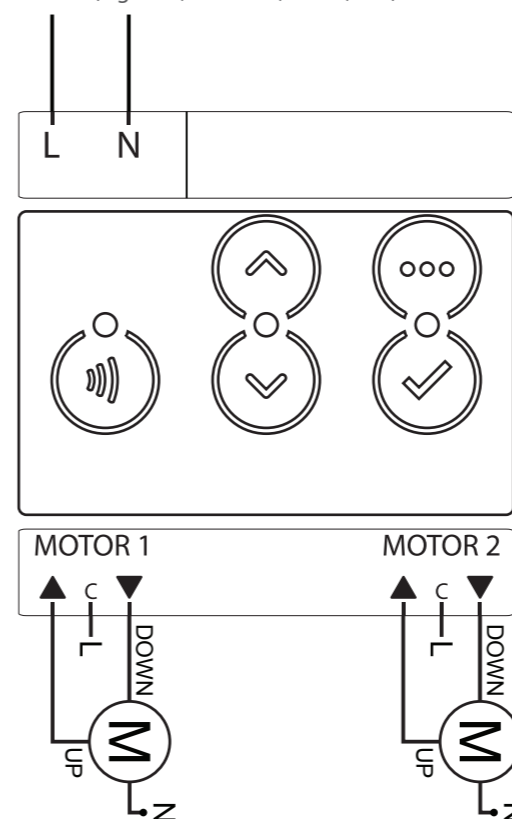

FUNCTIONS

Buttons and LEDs are numbered according the picture below facing front the device.

Each button has an RGB back-light LED that shows different colours during normal operation and certain sequence are also used to report special status.

Button #1 is used as **z-wave network button**

USABILITY

For actives the Din Rail Module by Vitrum Design follow the instructions Press the Menu key (# 3) for 4 seconds, use the direction keys (# 2 and # 4) to select the desired channel and press the selection key (# 5) to switch the selected relay or dimmer. To exit the menu, hold down the Menu key (# 3) for 4 seconds or after 30 seconds of inactivity, the device automatically exits the selection menu.

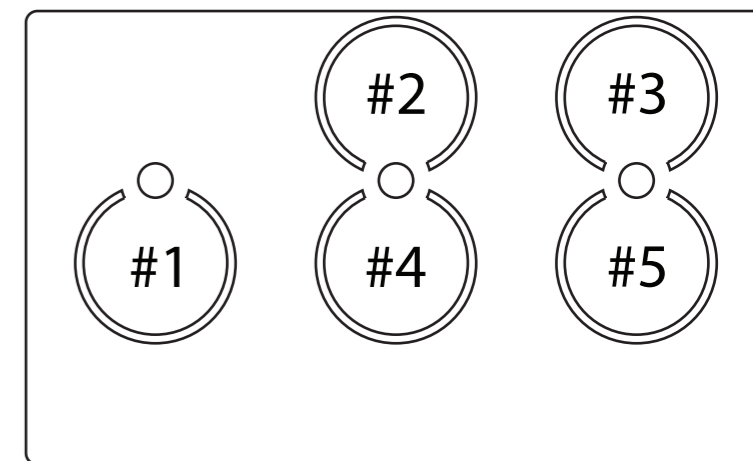

Special condition or status

LED	Colour codes	Description
LED #1	<i>blinks green for 5s</i>	<i>Valid HW signature detected at boot</i>
	<i>blinks red for 5s</i>	<i>Invalid HW signature detected at boot</i>
	<i>red glitch</i>	<i>When button #1 is touched indicates device is NOT included in the Z-Wave network</i>
	<i>Steady red</i>	<i>HW fault, contact assistance</i>

Normal operating condition or status

LED	Colour codes	Description
Any LED	<i>Steady blue</i>	<i>BASIC off or MULTILEVEL 0%</i>
	<i>Steady green</i>	<i>light dimming MULTILEVEL set at 33%</i>
	<i>Steady yellow</i>	<i>MULTILEVEL set at 100% or BASIC on</i>
	<i>Steady magenta</i>	<i>MOTOR control</i>

STANDARDS AND REGULATIONS

Electrical safety	(LVD) 2014/35/EU
Electromagnetic compatibility	(EMC) 2014/30/EU
Radio	(RED) 2014/53/EU
Presence of hazardous substances	(RoHS II) 2011/65/EU
Waste electrical and electronic equipment	(WEEE) 2012/19/EU

List of harmonized regulations applied

EN 301 489-1 V1.9.2; EN 301 489-3 V1.6.1
EN 50491-5-1:2010; EN 50491-5-2:2010
EN 60669-1:2000; EN 60669-1/A1:2003; EN60669-1/A2:2009
EN 60669-2-1:2004; EN 60669-2-1/A1:2009; EN 60669-2-1/A12:2009
EN 62479: 2010
EN 300 220-2 V.2.4.1





Model: RailZ-4M
Type: Switch-4CH
Code: 01D04H020
Protocol: Z-Wave Plus

INTRODUCTION

Purpose of this document

This manual describes the most essential functions and technical specifications to help the electrician to install, setup and control the device. It is a Z-Wave Plus device of the Vitrum 2.0 product range. Visit our website for the complete list.

This document is also available on our web-site.

Notice

Dispose cardboard box & holder, plastic bags and front plastic shell according to local recycling regulation. Box and holder are PAP recyclable, plastic bags are LDPE, front shell is PP.

Safety

Take care of your safety. Use only insulated tools and remove power from the mains circuit breakers before and during any installation activity.

Caution

This device is a permanently connected to the mains thus implies it is mandatory to have a readily accessible disconnect device (like a circuit breaker) incorporated in the general wiring of the building with at least 3mm separation between contacts.

Danger: Risk of electrocution

Device installation and maintenance must be carried out by trained and skilled electricians in accordance with local wiring and building regulations. The device has no basic insulation and must never be used without the front glass plate. It must be installed in a way that protect from accidental contact. During installation procedure, the dummy plastic cover must be left on.

Before and during installation disconnect mains power.

Before you start

You will need available and ready to use:

- Small Phillips isolated screw driver
- Small slotted isolated driver (alternate)

Package content

- 1 x Din Rail mountable device

Preparation

Remove carefully the device from the cardboard support. Keep this manual for further reference.

Features

Touch operated button with RGB back-light.
 Based on Z-Wave[®] 500 module for wider coverage and higher data rate.
 Very low power consumption in standby.
 Easy installation.
 Acoustic feedback at button press.
 Over-the-air firmware update.

Z-WAVE NETWORKING

This product can be included and operates in any Z-Wave network with other Z-Wave certified devices from other manufacturers and/or other applications. This device is an always powered node and within the network will act as repeater regardless of vendor to increase reliability of the network.

ADD (inclusion)

The device supports both Normal Inclusion and Network Wide Inclusion.

Follow the steps below to include the device into the network:

1. Check the device is not already included in a Z-Wave network by pressing the z-wave button [1] on the front panel: the LED on the button's circle should blink red shortly. If the LED blinks green the device is already included, follow the instructions below to exclude it from the network.
2. Set the controller into "Inclusion Mode". Refer to the controller documentation to set the controller into Inclusion mode.
3. Set the device into Learn Mode by pressing and holding the z-wave button [1] for longer than 4 seconds. The device will enter into inclusion mode by blinking magenta the button LED. Upon successful completion, the button LEDs of the device will blink green three times.
4. Should for any reasons the device fail the normal inclusion, the device turns to enter into the Network Wide Inclusion Mode up to 4 times. Any time the device enters into Wide Inclusion Mode, LED of the z-wave button blinks Magenta.

REMOVE (exclusion)

Before starting to exclude the device from the network set the controller into "Exclusion Mode". Please refer to the controller documentation to set the controller into Exclusion mode.

The device can be excluded from a network only if previously included. Check that by pressing the z-wave button [1] on the front panel: the LED button should shortly blink with green colour.

Follow the steps below to exclude the device from the network:

1. Press and hold the z-wave button [1] until the button LED blinks magenta and after that press 3 times the same button within 3 seconds.
2. The LED Buttons blink red upon completely the device exclusion successfully.
3. Check the device is removed from the network by pressing the z-wave button [1] its LED button blinks red shortly.

Node Info Frame

Follow the steps below to send a Node Info Frame:

1. Press shortly the radio button (first button on the left). After pressing it there will be a short audio signal (*beep*), within the radio Node Info
2. Go to *menu* to send a multichannel capability report

Firmware Update

This device supports the firmware update which can be started from any certified Z-Wave controller supporting the Firmware Update Command Class version 3 and above. While updating the device works normally. Just when the firmware update completes, the device will be inactive for few seconds during self-programming and rebooting.

During the reboot process, the local loads (if present) will be disengaged. Should the firmware update fail, the whole updating process must be restarted from the beginning.

The updating will last from 10 to 30 minutes depending on the network traffic condition.

Factory Default procedure

1. Press and hold the SELECT button [...] to enter the menu. The button LED will blink in white, keep pressing until the device will beep 3 times and the button LED will turn steady white. (**except the model EU 3M**)
2. Press again the SELECT button [...] until the button LED will turns red.
3. Press the SET button [v] till the buzzer plays a long beep (5 s).
4. Release the button and press it again till the buzzer plays a sequence of 3 short beeps.

The device will revert to its factory default settings, blinking all LED buttons and rebooting.

Do not disconnect the device from the power supply until reboot is completed.

Configuration and settings are restored to default values. "Home ID" and "Node ID" will be cleared as well.

ASSOCIATION/MULTICHANNEL ASSOCIATION

Association enables the device to control other nodes included in the same Z-Wave network for a maximum of **20 nodes** for **each button/group** with max **10 endpoints per Node**.

Group 1 Lifeline Notification

Max 20 associations available, Singlechannel or Multichannel.

Warning: In order to enable a controller to receive notifications with a endpoint source address from a Multichannel device, the controller must be associated to the lifeline group with the Multichannel association command class.

Example: if controller Node ID is 1, MULTICHANNEL ASSOCIATION must be set to the lifeline group 1 with controller nodeID(1) and endpoint(1)

Group 2 Reserved

Group 3 MAX_NODES_IN_GROUP 20

MAX_END_POINTS per Node: 10

Single channel association is only for root device so if used in a Multichannel environment the source and destination endpoint are lost. Multichannel Association instead contains the Source Endpoint and the Destination Endpoint so the device is addressed correctly.

General Rule for Groups

Each button has a dedicated group starting from #3 so button #1 is referred to **Group 3**, button #2 will control all the devices associated into group number 4 and so on. The number of groups depends on the number of endpoints (buttons). See table below for group association to buttons.

Messages sent by each group to associated devices are related to the "configuration type" of the endpoints.

Group N.	Button N.	Notes
1	-	Lifeline
2	-	Reserved
3	1	Always present
4	2	If present
5	3	If present
6	4	If present
7	5	If present
8	6	If present

PARAMETERS LIST

All parameters depends on their SIZE value. Size can be different from the table below. Before placing a "parameter #, SET value", always ask for a "Parameter #, GET" to retrieve the correct SIZE dimension.

See table below for the complete list of Configuration command Class parameters for all Vitrum products.

Description	Par. N. (Dec)	Size (B)	Value range	Default value
EP Type Button				
EP Type Button N.1 to N.6	1 to 6	1	0-26	Depends on specific device
End Point Type values				
EP_OFF			0	
EP_DIMMER			1 CC SWITCH MULTILEVEL - see par 31 to 36	
EP_SWITCHBUTTON			2 CC BASIC - see par 31 to 36	
EP_PUSHBUTTON			3 CC BASIC - see par 31 to 36	
EP_CURTAIN_1 Button			4 motor control with 1 button	
EP_CURTAIN			5 motor control with 2 buttons	
EP_MASTER_OFF			15 TBC	
EP_CURTAIN_UP			27 motor only up	
EP_CURTAIN_DOWN			28 motor only down	
Button Off Color				
Button N.1 to N.6 Off Color status	7 to 12	1	0-7	3
Button On Color				

Description	Par. N. (Dec)	Size (B)	Value range	Default value
Button N.1 to N.6 On Color status	13 to 18	1	0-7	4
Button Eco Color				
Button N.1 to N.6 Eco Color status	19 to 24	1	0-7	2
Button On/Off/Eco Color values list				
LED_COLOR_OFF	0			
LED_COLOR_RED	1			
LED_COLOR_GREEN	2			
LED_COLOR_BLU	3			
LED_COLOR_YELLOW	4			
LED_COLOR_MAGENTA	5			
LED_COLOR_CYAN	6			
LED_COLOR_WHITE	7			

Button to Output Port connection

Output Port connected to Button N.1 to N.6	25 to 30	1	0-6	
Output Port				
Not connected to any port	0			
Output Port N.1 to N.6 connected to button	1 to 6			
Basic or Multilevel SET max value type	31 to 36	1	0 = 0x63 (100%) 1 = 0xFF (last level)	0: 0x63

Motors Control Time

Channel 0 to 2 Motor Control Time (s)	191 to 193	1		60 (60 s)
Channel 0 Motor Control Switch All behavior (*1)	194	1		0
Channel 1 Motor Control Switch All behavior	195	1		0
Channel 2 Motor Control Switch All behavior	196	1		0
Lifeline queue time delay: <i>Add some delay to lifeline notifications</i>	215	2	1= 10 mS 10=100 mS 100=1000 mS	
NWI Enable	216	1	1: NWI enabled, default 0: learn mode classic only	
Multichannel Capability Report notification: Endpoint presentation after multichannel transmission	217	1	0: disabled, default 1: low power 2: Full Power	
Keyboard Lock Outputs and back-light still working 1. Lifeline notification CCConfig[218, 1] If a locked button is pressed 2. Force unlock: triple press on button 1 as per inclusion process -> BIP... BIP-BIP	218	1	0: unlock 1: lock	0: unlock
Triac safe mode when an EP is transformed in to curtain the corresponding Triac is disabled (only for triac dev.)	221	1	0:unable 1:disable	N/A

Example of End Point Type values:

Button configured as EP_CENTRAL_SCENE. It sends through the Lifeline association group the "Central Scene Notification" commands. (CMD_Key_Pressed,CMD_Key_Released,CMD_Key_Held_Down). To set an EP_CENTRAL_SCENE use the Configuration command Class parameter 1->6, value 0x1A.

NODE CAPABILITIES

Basic, Generic and Specific Device Class

Informations below Reported from Node Information Frame (NIF)

NIF PARAMETER DESCRIPTOR	LIBRARY IDENTIFIER
Basic Device Class	BASIC_TYPE_ROUTING_SLAVE Routing Slave Enhanced 232
Generic Device Class	GENERIC_TYPE_SWITCH_BINARY
Specific Device Class	SPECIFIC_TYPE_POWER_SWITCH_BINARY

Command Classes

Informations below Reported from:

- Node Information Frame (NIF)
- Version CC, Version Get and Report commands

COMMAND CLASS	LIBRARY IDENTIFIER	VERSION
Z-Wave Plus Info	COMMAND_CLASS_ZWAVEPLUS_INFO	2
Version	COMMAND_CLASS_VERSION	2
Manufacturer Specific	COMMAND_CLASS_MANUFACTURER_SPECIFIC	2
Device Reset Locally	COMMAND_CLASS_DEVICE_RESET_LOCALLY	1
Powerlevel	COMMAND_CLASS_POWERLEVEL	1
Firmware Update Meta Data	COMMAND_CLASS_FIRMWARE_UPDATE_MD	4
Association	COMMAND_CLASS_ASSOCIATION	2
Multi Channel Association	COMMAND_CLASS_MULTI_CHANNEL_ASSOCIATION	3
AGI (Association Gorup Info)	COMMAND_CLASS_ASSOCIATION_GRP_INFO	1
Multi Channel	COMMAND_CLASS_MULTI_CHANNEL	4
Configuration	COMMAND_CLASS_CONFIGURATION	1
Manufacturer Proprietary	COMMAND_CLASS_MANUFACTURER_PROPRIETARY	1
Indicator	COMMAND_CLASS_INDICATOR	1
Node Name and Location	COMMAND_CLASS_NODE_NAMING	1
All Switch	COMMAND_CLASS_SWITCH_ALL	1
COMMAND CLASS MARK		
Scene Activation	COMMAND_CLASS_SCENE_ACTIVATION	1
Central Scene	COMMAND_CLASS_CENTRAL_SCENE	1
Multilevel Switch	COMMAND_CLASS_SWITCH_MULTILEVEL	4
Binary Switch	COMMAND_CLASS_SWITCH_BINARY	1
Basic	COMMAND_CLASS_BASIC	1

Command Class Specification

COMMAND CLASS BASIC SET: MAX Value = [0x63 o 0xFF] -> [par31->36]
COMMAND CLASS INDICATOR values 0-7,0xFF

The version implemented is the #1 and may turn the device as a blinking indicator. The supported values are 0x00 (off/disable) or 0xFF (on/enable) and the field may carry valid values from 1 to 7.

0xFF: StartBlink(ALL_CHANNELS, YELLOW);
0x00: StopBlink(ALL_CHANNELS);

Valid values are:

1: white, 2: blue, 3: green, 4: cyan, 5: red, 6: magenta, 7: yellow

Timeout: ~60s

Generic and Specific Device Class by Curtain Endpoint

Informations below reported from Multi Channel Capability Report Command, valid if endpoint is set as "CURTAIN" only.

PARAMETER DESCRIPTOR	DESCRIPTION	LIBRARY IDENTIFIER
Generic Device Class	Switch Multilevel	GENERIC_TYPE_SWITCH_MULTILEVEL
Specific Device Class	Class A Motor Control	SPECIFIC_TYPE_CLASS_A_MOTOR_CONTROL

SUPPORTED COMMAND CLASS BY ENDPOINT

Informations below reported from Multi Channel Capability Report Command:

COMMAND CLASS	LIBRARY IDENTIFIER	VERSION
Binary	COMMAND_CLASS_SWITCH_BINARY	1
Multilevel Switch	COMMAND_CLASS_SWITCH_MULTILEVEL	4

DYNAMIC ENDPOINT EXPLANATION

Endpoints 1, 2, 3, set as "CURTAIN", are linked with endpoints 4, 5, 6 in vertical pairs, so endpoint 1 (direction up) is linked to endpoint 4 (direction down), and so on. Therefore endpoint 4, 5, 6, will not be "INTEROPERABLE" if a multichannel capability get is requested.

The valid endpoint association groups will be only 3, 4, 5. Relevant parameters are 191-196.

SPECIFICATIONS

Manufacturer ID: 0x010A

Models and Frequencies

REGION	CODE	FREQUENCY	PRODUCT TYPE ID	PRODUCT ID	APP ID
EU	01D04H020	868.4 Mhz	0x7115	0x1016	0x0215
IL	01DE40020	916 Mhz	0x7006	0x0F07	0x0106
KR	01DB4H020	921.4 Mhz	0x7116	0x1017	0x0216

Technical Specifications

Operating voltage	230 VAC 50 Hz
Consumption	<1.5W standby
Operating temperature	from 0°C to +40°C
Operating Humidity	20% - 90% RH non condensing
Storage temperature	from -40°C to +55°C
Storage Humidity	10% - 93% RH non condensing
IP Class	IP20
Package Dimension (W x H x D)	110 x 72 x 62 mm
Weight	~210 gr
RF radiated powered	2.5 mW (max)
RF range	Up to 40 m open range
Warranty	1 year

INSTALLATION

Wire the device according to the schematic below.

L Power connection (LIVE)
N Power connection (Neutral)

Position the device in the wall's mounting box and check cables are not interfering with the device case. Using the appropriate screw set that matches the wall box, fix the device in place without applying unnecessary torque to fixing screws.

Choosing a suitable location

Do not locate the device facing direct sunlight, humid or dusty place. The suitable ambient temperature is listed in specification.

Do not locate the device where there are any combustible substances or sources of heat (e.g. fires, radiators, boiler, etc.).

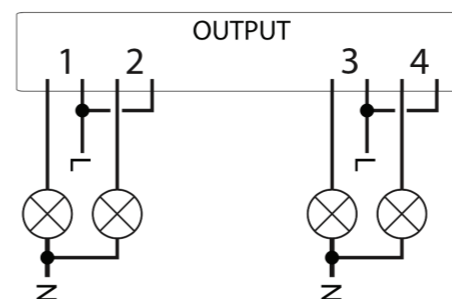
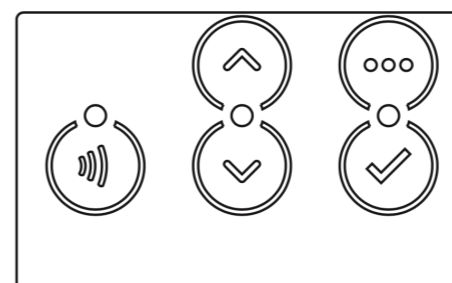

FUNCTIONS

Buttons and LEDs are numbered according the picture below facing front the device.

Each button has an RGB back-light LED that shows different colours during normal operation and certain sequence are also used to report special status.

Button #1 is used as **z-wave network button**

USABILITY

For actives the Din Rail Module by Vitrum Design follow the instructions Press the Menu key (# 3) for 4 seconds, use the direction keys (# 2 and # 4) to select the desired channel and press the selection key (# 5) to switch the selected relay or dimmer. To exit the menu, hold down the Menu key (# 3) for 4 seconds or after 30 seconds of inactivity, the device automatically exits the selection menu.

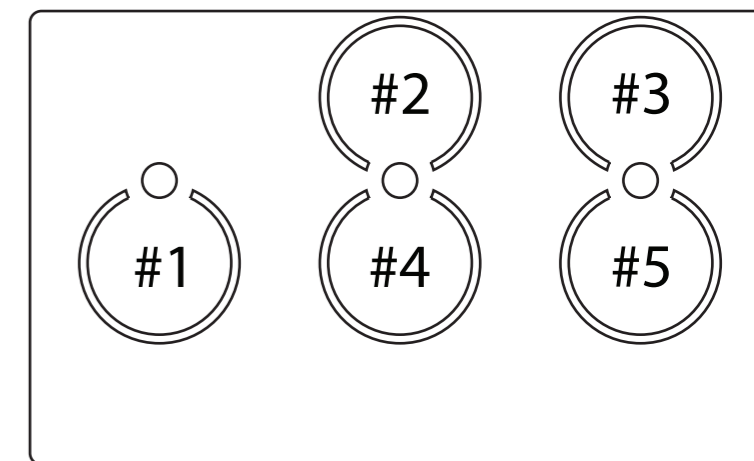

Special condition or status

LED	Colour codes	Description
LED #1	<i>blinks green for 5s</i>	<i>Valid HW signature detected at boot</i>
	<i>blinks red for 5s</i>	<i>Invalid HW signature detected at boot</i>
	<i>red glitch</i>	<i>When button #1 is touched indicates device is NOT included in the Z-Wave network</i>
	<i>Steady red</i>	<i>HW fault, contact assistance</i>

Normal operating condition or status

LED	Colour codes	Description
Any LED	<i>Steady blue</i>	<i>BASIC off or MULTILEVEL 0%</i>
	<i>Steady green</i>	<i>light dimming MULTILEVEL set at 33%</i>
	<i>Steady yellow</i>	<i>MULTILEVEL set at 100% or BASIC on</i>
	<i>Steady magenta</i>	<i>MOTOR control</i>

STANDARDS AND REGULATIONS

Electrical safety	(LVD) 2014/35/EU
Electromagnetic compatibility	(EMC) 2014/30/EU
Radio	(RED) 2014/53/EU
Presence of hazardous substances	(RoHS II) 2011/65/EU
Waste electrical and electronic equipment	(WEEE) 2012/19/EU

List of harmonized regulations applied

EN 301 489-1 V1.9.2; EN 301 489-3 V1.6.1
EN 50491-5-1:2010; EN 50491-5-2:2010
EN 60669-1:2000; EN 60669-1/A1:2003; EN60669-1/A2:2009
EN 60669-2-1:2004; EN 60669-2-1/A1:2009; EN 60669-2-1/A12:2009
EN 62479: 2010
EN 300 220-2 V.2.4.1





Model: WallZ-503
Type: 1CH-1RL
Code: 3M-01E01H020 4M- 01Q01H020
Protocol: Z-Wave Plus

INTRODUCTION

Purpose of this document

This manual describes the most essential functions and technical specifications to help the electrician to install, setup and control the device. It is a Z-Wave Plus device of the Vitrum 2.0 product range. Visit our website for the complete list.

This document is also available on our web-site.

Notice

Dispose cardboard box & holder, plastic bags and front plastic shell according to local recycling regulation. Box and holder are PAP recyclable, plastic bags are LDPE, front shell is PP.

Safety

Take care of your safety. Use only insulated tools and remove power from the mains circuit breakers before and during any installation activity.

Caution

This device is a permanently connected to the mains thus implies it is mandatory to have a readily accessible disconnect device (like a circuit breaker) incorporated in the general wiring of the building with at least 3mm separation between contacts.

Danger: Risk of electrocution

Device installation and maintenance must be carried out by trained and skilled electricians in accordance with local wiring and building regulations. The device has no basic insulation and must never be used without the front glass plate. It must be installed in a way that protect from accidental contact. During installation procedure, the dummy plastic cover must be left on.

Before and during installation disconnect mains power.

Before you start

You will need available and ready to use:

- Small Phillips isolated screw driver
- Small slotted isolated driver (alternate)

Package content

- 1 x Wall mountable device
- 2 x Metric screw set
- 2 x Plastic screw set
- 1 x Protective shell

Preparation

Remove carefully the device from the cardboard support. Keep this manual for further reference.

Features

Touch operated button with RGB back-light.
 Based on Z-Wave[®] 500 module for wider coverage and higher data rate.
 Very low power consumption in standby.
 Easy installation.
 Acoustic feedback at button press.
 Over-the-air firmware update.

Z-WAVE NETWORKING

This product can be included and operates in any Z-Wave network with other Z-Wave certified devices from other manufacturers and/or other applications. This device is an always powered node and within the network will act as repeater regardless of vendor to increase reliability of the network.

ADD (inclusion)

The device supports both Normal Inclusion and Network Wide Inclusion.

Follow the steps below to include the device into the network:

1. Check the device is not already included in a Z-Wave network by pressing any button on the front panel: the LED button should blink with red colour shortly. Should the device be already included, follow the instructions below to excluded it from the network.
2. Set the controller into "Inclusion Mode". Refer to the controller documentation to set the controller into Inclusion mode.
3. Set the device into Learn Mode by pressing and holding button No.1 (on the top left of the device) for longer than 4 seconds. The device will enter into inclusion mode by blinking magenta LED button No.1. Upon successful completion, the device LEDs will blink green three times.
4. Should for any reasons the device fail the normal inclusion, the device turns to enter into the Network Wide Inclusion Mode up to 4 times. Any time the device enters into Wide Inclusion Mode, LED Button No.1 blinks Magenta.

REMOVE (exclusion)

Before starting to exclude the device from the network set the controller into "Exclusion Mode". Please refer to the controller documentation to set the controller into Exclusion mode.

The device can be excluded from a network only if previously included. Check that by pressing a button on the front panel: the LED button should not blink with red colour shortly.

Follow the steps below to exclude the device from the network:

1. Press and hold button No.1 (on the top left of the front panel device) for around 6 seconds and after that press 3 times the same button shortly within 3 seconds.
2. LED Button No.1 blinks red upon completely the device exclusion successfully.
3. Check the device is removed from the network by pressing button No.1: the LED button blinks red shortly.

Node Info Frame

To send a Node info frame press and release shortly the *HIDDEN BUTTON* (see picture on Installation paragraph) on the front end top-back of the device; a short audio signal (*beep*), will confirm the Node Info transmission.

If parameter 217 is set at 1 or 2 (see parameter table below), each button send a "Multichannel Capability Report". As default, parameter 217 is OFF.

Firmware Update

This device supports the firmware update which can be started from any certified Z-Wave controller supporting the Firmware Update Command Class version 3 and above. While updating the device works normally.

Just when the firmware update completes, the device will be inactive for few seconds during self-programming and rebooting.

During the reboot process, the local loads (if present) will be disengaged. Should the firmware update fail, the whole updating process must be re-started from the beginning.

The updating will last from 10 to 30 minutes depending on the network traffic condition.

Factory Default procedure

1. Start the factory default procedure by pressing and holding the hidden button on the front end top-back of the device till the buzzer plays a long beep (5 s).
2. Release the button and press it again till the buzzer plays a sequence of 3 short beeps.
3. The device will revert to its factory default settings, blinking all LED buttons and rebooting.

Do not disconnect the device from the power supply until reboot is completed.

Configuration and settings are restored to default values. "Home ID" and "Node ID" will be cleared as well.

ASSOCIATION/MULTICHANNEL ASSOCIATION

Association enables the device to control other nodes included in the same Z-Wave network for a maximum of **20 nodes** for **each button/group** with max **10 endpoints per Node**.

Group 1 Lifeline Notification

Max 20 associations available, Singlechannel or Multichannel.

Warning: In order to enable a controller to receive notifications with a endpoint source address from a Multichannel device, the controller must be associated to the lifeline group with the Multichannel association command class.

Example: if controller Node ID is 1, MULTICHANNEL ASSOCIATION must be set to the lifeline group 1 with controller nodeID(1) and endpoint(1)

Group 2 Reserved

Group 3 MAX_NODES_IN_GROUP 20

MAX_END_POINTS per Node: 10

Single channel association is only for root device so if used in a Multichannel environment the source and destination endpoint are lost. Multichannel Association instead contains the Source Endpoint and the Destination Endpoint so the device is addressed correctly.

General Rule for Groups

Each button has a dedicated group starting from #3 so button #1 is referred to **Group 3**, button #2 will control all the devices associated into group number 4 and so on. The number of groups depends on the number of endpoints (buttons). See table below for group association to buttons.

Messages sent by each group to associated devices are related to the "configuration type" of the endpoints.

Group N.	Button N.	Notes
1	-	Lifeline
2	-	Reserved
3	1	Always present
4	2	If present
5	3	If present
6	4	If present
7	5	If present
8	6	If present

PARAMETERS LIST

All parameters depends on their SIZE value. Size can be different from the table below. Before placing a "parameter #, SET value", always ask for a "Parameter #, GET" to retrieve the correct SIZE dimension.

See table below for the complete list of Configuration command Class parameters for all Vitrum products.

Description	Par. N. (Dec)	Size (B)	Value range	Default value
EP Type Button				
EP Type Button N.1 to N.6	1 to 6	1	0-26	Depends on specific device
End Point Type values				
EP_OFF	0			
EP_DIMMER	1		CC SWITCH MULTILEVEL - see par 31 to 36	
EP_SWITCHBUTTON	2		CC BASIC - see par 31 to 36	
EP_PUSHBUTTON	3		CC BASIC - see par 31 to 36	
EP_CURTAIN_1 Button	4		motor control with 1 button	
EP_CURTAIN	5		motor control with 2 buttons	
EP_MASTER_OFF	15		TBC	
EP_CURTAIN_UP	27		motor only up	
EP_CURTAIN_DOWN	28		motor only down	
Button Off Color				
Button N.1 to N.6 Off Color status	7 to 12	1	0-7	3
Button On Color				

Description	Par. N. (Dec)	Size (B)	Value range	Default value
Button N.1 to N.6 On Color status	13 to 18	1	0-7	4
Button Eco Color				
Button N.1 to N.6 Eco Color status	19 to 24	1	0-7	2
Button On/Off/Eco Color values list				
LED_COLOR_OFF	0			
LED_COLOR_RED	1			
LED_COLOR_GREEN	2			
LED_COLOR_BLU	3			
LED_COLOR_YELLOW	4			
LED_COLOR_MAGENTA	5			
LED_COLOR_CYAN	6			
LED_COLOR_WHITE	7			

Button to Output Port connection

Output Port connected to Button N.1 to N.6	25 to 30	1	0-6	
Output Port				
Not connected to any port	0			
Output Port N.1 to N.6 connected to button	1 to 6			
Basic or Multilevel SET max value type	31 to 36	1	0 = 0x63 (100%) 1 = 0xFF (last level)	0: 0x63

Motors Control Time

Channel 0 to 2 Motor Control Time (s)	191 to 193	1		60 (60 s)
Channel 0 Motor Control Switch All behavior (*1)	194	1		0
Channel 1 Motor Control Switch All behavior	195	1		0
Channel 2 Motor Control Switch All behavior	196	1		0
Lifeline queue time delay: <i>Add some delay to lifeline notifications</i>	215	2	1= 10 mS 10=100 mS 100=1000 mS	
NWI Enable	216	1	1: NWI enabled, default 0: learn mode classic only	
Multichannel Capability Report notification: Endpoint presentation after multichannel transmission	217	1	0: disabled, default 1: low power 2: Full Power	
Keyboard Lock Outputs and back-light still working 1. Lifeline notification CCConfig[218, 1] If a locked button is pressed 2. Force unlock: triple press on button 1 as per inclusion process -> BIP... BIP-BIP	218	1	0: unlock 1: lock	0: unlock
Triac safe mode when an EP is transformed in to curtain the corresponding Triac is disabled (only for triac dev.)	221	1	0:unable 1:disable	N/A

Example of End Point Type values:

Button configured as EP_CENTRAL_SCENE. It sends through the Lifeline association group the "Central Scene Notification" commands. (CMD_Key_Pressed,CMD_Key_Released,CMD_Key_Held_Down). To set an EP_CENTRAL_SCENE use the Configuration command Class parameter 1->6, value 0x1A.

NODE CAPABILITIES

Basic, Generic and Specific Device Class

Informations below Reported from Node Information Frame (NIF)

NIF PARAMETER DESCRIPTOR	LIBRARY IDENTIFIER
Basic Device Class	BASIC_TYPE_ROUTING_SLAVE Routing Slave Enhanced 232
Generic Device Class	GENERIC_TYPE_SWITCH_BINARY
Specific Device Class	SPECIFIC_TYPE_POWER_SWITCH_BINARY

Command Classes

Informations below Reported from:

- Node Information Frame (NIF)
- Version CC, Version Get and Report commands

COMMAND CLASS	LIBRARY IDENTIFIER	VERSION
Z-Wave Plus Info	COMMAND_CLASS_ZWAVEPLUS_INFO	2
Version	COMMAND_CLASS_VERSION	2
Manufacturer Specific	COMMAND_CLASS_MANUFACTURER_SPECIFIC	2
Device Reset Locally	COMMAND_CLASS_DEVICE_RESET_LOCALLY	1
Powerlevel	COMMAND_CLASS_POWERLEVEL	1
Firmware Update Meta Data	COMMAND_CLASS_FIRMWARE_UPDATE_MD	4
Association	COMMAND_CLASS_ASSOCIATION	2
Multi Channel Association	COMMAND_CLASS_MULTI_CHANNEL_ASSOCIATION	3
AGI (Association Gorup Info)	COMMAND_CLASS_ASSOCIATION_GRP_INFO	1
Multi Channel	COMMAND_CLASS_MULTI_CHANNEL	4
Configuration	COMMAND_CLASS_CONFIGURATION	1
Manufacturer Proprietary	COMMAND_CLASS_MANUFACTURER_PROPRIETARY	1
Indicator	COMMAND_CLASS_INDICATOR	1
Node Name and Location	COMMAND_CLASS_NODE_NAMING	1
All Switch	COMMAND_CLASS_SWITCH_ALL	1

COMMAND CLASS MARK

Scene Activation	COMMAND_CLASS_SCENE_ACTIVATION	1
Central Scene	COMMAND_CLASS_CENTRAL_SCENE	1
Multilevel Switch	COMMAND_CLASS_SWITCH_MULTILEVEL	4
Binary Switch	COMMAND_CLASS_SWITCH_BINARY	1
Basic	COMMAND_CLASS_BASIC	1

Command Class Specification

COMMAND CLASS BASIC SET: MAX Value = [0x63 o 0xFF] -> [par31->36]
COMMAND CLASS INDICATOR values 0-7,0xFF

The version implemented is the #1 and may turn the device as a blinking indicator. The supported values are 0x00 (off/disable) or 0xFF (on/enable) and the field may carry valid values from 1 to 7.

0xFF: StartBlink(ALL_CHANNELS, YELLOW);
0x00: StopBlink(ALL_CHANNELS);

Valid values are:

1: white, 2: blue, 3: green, 4: cyan, 5: red, 6: magenta, 7: yellow

Timeout: ~60s

Generic and Specific Device Class by Curtain Endpoint

Informations below reported from Multi Channel Capability Report Command, valid if endpoint is set as "CURTAIN" only.

PARAMETER DESCRIPTOR	DESCRIPTION	LIBRARY IDENTIFIER
Generic Device Class	Switch Multilevel	GENERIC_TYPE_SWITCH_MULTILEVEL
Specific Device Class	Class A Motor Control	SPECIFIC_TYPE_CLASS_A_MOTOR_CONTROL

SUPPORTED COMMAND CLASS BY ENDPOINT

Informations below reported from Multi Channel Capability Report Command:

COMMAND CLASS	LIBRARY IDENTIFIER	VERSION
Binary	COMMAND_CLASS_SWITCH_BINARY	1
Multilevel Switch	COMMAND_CLASS_SWITCH_MULTILEVEL	4

DYNAMIC ENDPOINT EXPLANATION

Endpoints 1, 2, 3, set as "CURTAIN", are linked with endpoints 4, 5, 6 in vertical pairs, so endpoint 1 (direction up) is linked to endpoint 4 (direction down), and so on. Therefore endpoint 4, 5, 6, will not be "INTEROPERABLE" if a multichannel capability get is requested.

The valid endpoint association groups will be only 3, 4, 5. Relevant parameters are 191-196.

SPECIFICATIONS

Manufacturer ID: 0x010A

Models and Frequencies

REGION	CODE	FREQUENCY	PRODUCT TYPE ID	PRODUCT ID	APP ID
EU	01E01H020	868.4 Mhz	0x7115	0x1016	0x0215
IL	01EE10020	916 Mhz	0x7006	0x0F07	0x0106
KR	01EB1H020	921.4 Mhz	0x7116	0x1017	0x0216

Technical Specifications

Operating voltage	230 VAC 50 Hz
Consumption	<1.5W standby
Operating temperature	from 0°C to +40°C
Operating Humidity	20% - 90% RH non condensing
Storage temperature	from -40°C to +55°C
Storage Humidity	10% - 93% RH non condensing
IP Class	IP20
Package Dimension (W x H x D)	135 x 50 x 170 mm
Weight	~210 gr
RF radiated powered	2.5 mW (max)
RF range	Up to 40 m open range
Warranty	1 year

INSTALLATION

Wire the device according to the schematic below.

- L Power connection (LIVE)
- N Power connection (Neutral)

Position the device in the wall's mounting box and check cables are not interfering with the device case. Using the appropriate screw set that matches the wall box, fix the device in place without applying unnecessary torque to fixing screws.

Choosing a suitable location

Do not locate the device facing direct sunlight, humid or dusty place. The suitable ambient temperature is listed in specification.

Do not locate the device where there are any combustible substances or sources of heat (e.g. fires, radiators, boiler, etc.).

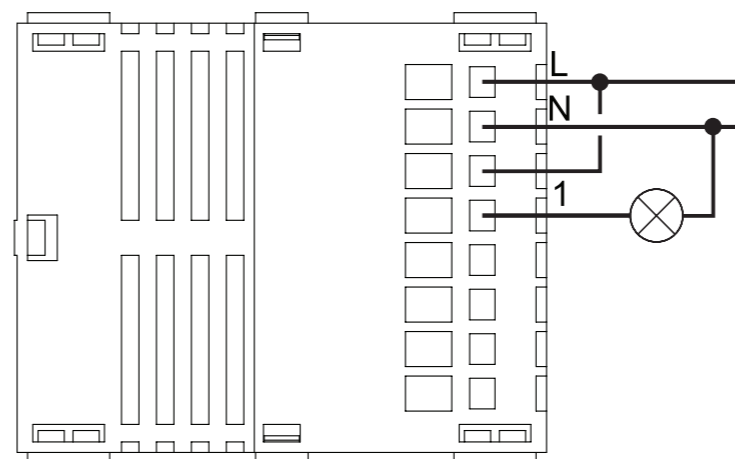

FUNCTIONS

Buttons and LEDs are numbered according the picture below facing front the device.

Each button has an RGB back-light LED that shows different colours during normal operation and certain sequence are also used to report special status.

Button #1 is used as **z-wave network button**

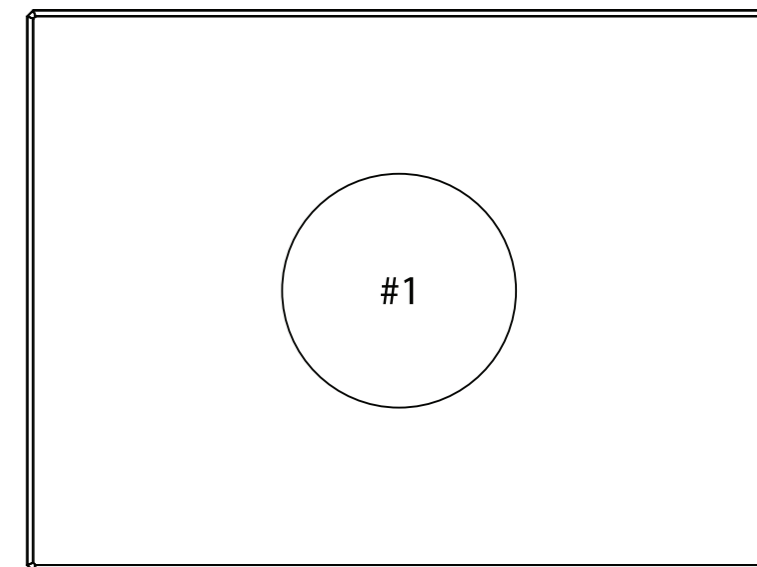

Special condition or status

LED	Colour codes	Description
LED #1	<i>blinks green for 5s</i>	<i>Valid HW signature detected at boot</i>
	<i>blinks red for 5s</i>	<i>Invalid HW signature detected at boot</i>
	<i>red glitch</i>	<i>When button #1 is touched indicates device is NOT included in the Z-Wave network</i>
	<i>Steady red</i>	<i>HW fault, contact assistance</i>

Normal operating condition or status

LED	Colour codes	Description
Any LED	<i>Steady blue</i>	<i>BASIC off or MULTILEVEL 0%</i>
	<i>Steady green</i>	<i>light dimming MULTILEVEL set at 33%</i>
	<i>Steady yellow</i>	<i>MULTILEVEL set at 100% or BASIC on</i>
	<i>Steady magenta</i>	<i>MOTOR control</i>

STANDARDS AND REGULATIONS

Electrical safety	(LVD) 2014/35/EU
Electromagnetic compatibility	(EMC) 2014/30/EU
Radio	(RED) 2014/53/EU
Presence of hazardous substances	(RoHS II) 2011/65/EU
Waste electrical and electronic equipment	(WEEE) 2012/19/EU

List of harmonized regulations applied

EN 301 489-1 V1.9.2; EN 301 489-3 V1.6.1
EN 50491-5-1:2010; EN 50491-5-2:2010
EN 60669-1:2000; EN 60669-1/A1:2003; EN60669-1/A2:2009
EN 60669-2-1:2004; EN 60669-2-1/A1:2009; EN 60669-2-1/A12:2009
EN 62479: 2010
EN 300 220-2 V.2.4.1



Vitrum EU II Single Shutter Cloud



Model: WallZ-503
Type: 1CH-1M
Code: 3M-02E02H011 4M- 02Q02H11
Protocol: Z-Wave Plus

INTRODUCTION

Purpose of this document

This manual describes the most essential functions and technical specifications to help the electrician to install, setup and control the device. It is a Z-Wave Plus device of the Vitrum 2.0 product range. Visit our website for the complete list.

This document is also available on our web-site.

Notice

Dispose cardboard box & holder, plastic bags and front plastic shell according to local recycling regulation. Box and holder are PAP recyclable, plastic bags are LDPE, front shell is PP.

Safety

Take care of your safety. Use only insulated tools and remove power from the mains circuit breakers before and during any installation activity.

Caution

This device is a permanently connected to the mains thus implies it is mandatory to have a readily accessible disconnect device (like a circuit breaker) incorporated in the general wiring of the building with at least 3mm separation between contacts.

Danger: Risk of electrocution

Device installation and maintenance must be carried out by trained and skilled electricians in accordance with local wiring and building regulations. The device has no basic insulation and must never be used without the front glass plate. It must be installed in a way that protect from accidental contact. During installation procedure, the dummy plastic cover must be left on.

Before and during installation disconnect mains power.

Before you start

You will need available and ready to use:

- Small Phillips isolated screw driver
- Small slotted isolated driver (alternate)

Package content

- 1 x Wall mountable device
- 2 x Metric screw set
- 2 x Plastic screw set
- 1 x Protective shell

Preparation

Remove carefully the device from the cardboard support. Keep this manual for further reference.

Features

Touch operated button with RGB back-light.
 Based on Z-Wave[®] 500 module for wider coverage and higher data rate.
 Very low power consumption in standby.
 Easy installation.
 Acoustic feedback at button press.
 Over-the-air firmware update.

Z-WAVE NETWORKING

This product can be included and operates in any Z-Wave network with other Z-Wave certified devices from other manufacturers and/or other applications. This device is an always powered node and within the network will act as repeater regardless of vendor to increase reliability of the network.

ADD (inclusion)

The device supports both Normal Inclusion and Network Wide Inclusion.

Follow the steps below to include the device into the network:

1. Check the device is not already included in a Z-Wave network by pressing any button on the front panel: the LED button should blink with red colour shortly. Should the device be already included, follow the instructions below to excluded it from the network.
2. Set the controller into "Inclusion Mode". Refer to the controller documentation to set the controller into Inclusion mode.
3. Set the device into Learn Mode by pressing and holding button No.1 (on the top left of the device) for longer than 4 seconds. The device will enter into inclusion mode by blinking magenta LED button No.1. Upon successful completion, the device LEDs will blink green three times.
4. Should for any reasons the device fail the normal inclusion, the device turns to enter into the Network Wide Inclusion Mode up to 4 times. Any time the device enters into Wide Inclusion Mode, LED Button No.1 blinks Magenta.

REMOVE (exclusion)

Before starting to exclude the device from the network set the controller into "Exclusion Mode". Please refer to the controller documentation to set the controller into Exclusion mode.

The device can be excluded from a network only if previously included. Check that by pressing a button on the front panel: the LED button should not blink with red colour shortly.

Follow the steps below to exclude the device from the network:

1. Press and hold button No.1 (on the top left of the front panel device) for around 6 seconds and after that press 3 times the same button shortly within 3 seconds.
2. LED Button No.1 blinks red upon completely the device exclusion successfully.
3. Check the device is removed from the network by pressing button No.1: the LED button blinks red shortly.

Node Info Frame

To send a Node info frame press and release shortly the *HIDDEN BUTTON* (see picture on Installation paragraph) on the front end top-back of the device; a short audio signal (*beep*), will confirm the Node Info transmission.

If parameter 217 is set at 1 or 2 (see parameter table below), each button send a "Multichannel Capability Report". As default, parameter 217 is OFF.

Firmware Update

This device supports the firmware update which can be started from any certified Z-Wave controller supporting the Firmware Update Command Class version 3 and above. While updating the device works normally.

Just when the firmware update completes, the device will be inactive for few seconds during self-programming and rebooting.

During the reboot process, the local loads (if present) will be disengaged. Should the firmware update fail, the whole updating process must be re-started from the beginning.

The updating will last from 10 to 30 minutes depending on the network traffic condition.

Factory Default procedure

1. Start the factory default procedure by pressing and holding the hidden button on the front end top-back of the device till the buzzer plays a long beep (5 s).
2. Release the button and press it again till the buzzer plays a sequence of 3 short beeps.
3. The device will revert to its factory default settings, blinking all LED buttons and rebooting.

Do not disconnect the device from the power supply until reboot is completed.

Configuration and settings are restored to default values. "Home ID" and "Node ID" will be cleared as well.

ASSOCIATION/MULTICHANNEL ASSOCIATION

Association enables the device to control other nodes included in the same Z-Wave network for a maximum of **20 nodes** for **each button/group** with max **10 endpoints per Node**.

Group 1 Lifeline Notification

EP_OFF	0
EP_CURTAIN	5 MOTOR CONTROL WITH 2 BUTTONS

Group 3 MAX_NODES_IN_GROUP 20

MAX_END_POINTS per Node: 10

Single channel association is only for root device so if used in a Multichannel environment the source and destination endpoint are lost. Multichannel Association instead contains the Source Endpoint and the Destination Endpoint so the device is addressed correctly.

General Rule for Groups

Each button has a dedicated group starting from #3 so button #1 is referred to **Group 3**, button #2 will control all the devices associated into group number 4 and so on. The number of groups depends on the number of endpoints (buttons). See table below for group association to buttons.

Messages sent by each group to associated devices are related to the "configuration type" of the endpoints.

Group N.	Button N.	Notes
1	-	Lifeline
2	-	Reserved
3	1	Always present
4	2	If present
5	3	If present
6	4	If present
7	5	If present
8	6	If present

PARAMETERS LIST

All parameters depends on their SIZE value. Size can be different from the table below. Before placing a "parameter #, SET value", always ask for a "Parameter #, GET" to retrieve the correct SIZE dimension.

See table below for the complete list of Configuration command Class parameters for all Vitrum products.

Description	Par. N. (Dec)	Size (B)	Value range	Default value
EP Type Button				
EP Type Button N.1 to N.6	1 to 6	1	0-26	Depends on specific device
End Point Type values				
EP_OFF	0			
EP_DIMMER	1		CC SWITCH MULTILEVEL - see par 31 to 36	
EP_SWITCHBUTTON	2		CC BASIC - see par 31 to 36	
EP_PUSHBUTTON	3		CC BASIC - see par 31 to 36	
EP_CURTAIN_1 Button	4		motor control with 1 button	
EP_CURTAIN	5		motor control with 2 buttons	
EP_MASTER_OFF	15		TBC	
EP_CURTAIN_UP	27		motor only up	
EP_CURTAIN_DOWN	28		motor only down	
Button Off Color				
Button N.1 to N.6 Off Color status	7 to 12	1	0-7	3
Button On Color				

Description	Par. N. (Dec)	Size (B)	Value range	Default value
Button N.1 to N.6 On Color status	13 to 18	1	0-7	4
Button Eco Color				
Button N.1 to N.6 Eco Color status	19 to 24	1	0-7	2
Button On/Off/Eco Color values list				
LED_COLOR_OFF	0			
LED_COLOR_RED	1			
LED_COLOR_GREEN	2			
LED_COLOR_BLU	3			
LED_COLOR_YELLOW	4			
LED_COLOR_MAGENTA	5			
LED_COLOR_CYAN	6			
LED_COLOR_WHITE	7			

Button to Output Port connection

Output Port connected to Button N.1 to N.6	25 to 30	1	0-6	
Output Port				
Not connected to any port	0			
Output Port N.1 to N.6 connected to button	1 to 6			
Basic or Multilevel SET max value type	31 to 36	1	0 = 0x63 (100%) 1 = 0xFF (last level)	0: 0x63

Motors Control Time

Channel 0 to 2 Motor Control Time (s)	191 to 193	1		60 (60 s)
Channel 0 Motor Control Switch All behavior (*1)	194	1		0
Channel 1 Motor Control Switch All behavior	195	1		0
Channel 2 Motor Control Switch All behavior	196	1		0
Lifeline queue time delay: <i>Add some delay to lifeline notifications</i>	215	2	1= 10 mS 10=100 mS 100=1000 mS	
NWI Enable	216	1	1: NWI enabled, default 0: learn mode classic only	
Multichannel Capability Report notification: Endpoint presentation after multichannel transmission	217	1	0: disabled, default 1: low power 2: Full Power	
Keyboard Lock Outputs and back-light still working 1. Lifeline notification CCConfig[218, 1] If a locked button is pressed 2. Force unlock: triple press on button 1 as per inclusion process -> BIP... BIP-BIP	218	1	0: unlock 1: lock	0: unlock
Triac safe mode when an EP is transformed in to curtain the corresponding Triac is disabled (only for triac dev.)	221	1	0:unable 1:disable	N/A

Example of End Point Type values:

Button configured as EP_CENTRAL_SCENE. It sends through the Lifeline association group the "Central Scene Notification" commands. (CMD_Key_Pressed, CMD_Key_Released, CMD_Key_Held_Down). To set an EP_CENTRAL_SCENE use the Configuration command Class parameter 1->6, value 0x1A.

NODE CAPABILITIES

Basic, Generic and Specific Device Class

Informations below Reported from Node Information Frame (NIF)

NIF PARAMETER DESCRIPTOR	LIBRARY IDENTIFIER
Basic Device Class	BASIC_TYPE_ROUTING_SLAVE Routing Slave Enhanced 232
Generic Device Class	GENERIC_TYPE_SWITCH_BINARY
Specific Device Class	SPECIFIC_TYPE_POWER_SWITCH_BINARY

Command Classes

Informations below Reported from:

- Node Information Frame (NIF)
- Version CC, Version Get and Report commands

COMMAND CLASS	LIBRARY IDENTIFIER	VERSION
Z-Wave Plus Info	COMMAND_CLASS_ZWAVEPLUS_INFO	2
Version	COMMAND_CLASS_VERSION	2
Manufacturer Specific	COMMAND_CLASS_MANUFACTURER_SPECIFIC	2
Device Reset Locally	COMMAND_CLASS_DEVICE_RESET_LOCALLY	1
Powerlevel	COMMAND_CLASS_POWERLEVEL	1
Firmware Update Meta Data	COMMAND_CLASS_FIRMWARE_UPDATE_MD	4
Association	COMMAND_CLASS_ASSOCIATION	2
Multi Channel Association	COMMAND_CLASS_MULTI_CHANNEL_ASSOCIATION	3
AGI (Association Gorup Info)	COMMAND_CLASS_ASSOCIATION_GRP_INFO	1
Multi Channel	COMMAND_CLASS_MULTI_CHANNEL	4
Configuration	COMMAND_CLASS_CONFIGURATION	1
Manufacturer Proprietary	COMMAND_CLASS_MANUFACTURER_PROPRIETARY	1
Indicator	COMMAND_CLASS_INDICATOR	1
Node Name and Location	COMMAND_CLASS_NODE_NAMING	1
All Switch	COMMAND_CLASS_SWITCH_ALL	1

COMMAND CLASS MARK

Scene Activation	COMMAND_CLASS_SCENE_ACTIVATION	1
Central Scene	COMMAND_CLASS_CENTRAL_SCENE	1
Multilevel Switch	COMMAND_CLASS_SWITCH_MULTILEVEL	4
Binary Switch	COMMAND_CLASS_SWITCH_BINARY	1
Basic	COMMAND_CLASS_BASIC	1

Command Class Specification

COMMAND CLASS BASIC SET: MAX Value = [0x63 o 0xFF] -> [par31->36]
COMMAND CLASS INDICATOR values 0-7,0xFF

The version implemented is the #1 and may turn the device as a blinking indicator. The supported values are 0x00 (off/disable) or 0xFF (on/enable) and the field may carry valid values from 1 to 7.

0xFF: StartBlink(ALL_CHANNELS, YELLOW);
0x00: StopBlink(ALL_CHANNELS);

Valid values are:

1: white, 2: blue, 3: green, 4: cyan, 5: red, 6: magenta, 7: yellow

Timeout: ~60s

Generic and Specific Device Class by Curtain Endpoint

Informations below reported from Multi Channel Capability Report Command, valid if endpoint is set as "CURTAIN" only.

PARAMETER DESCRIPTOR	DESCRIPTION	LIBRARY IDENTIFIER
Generic Device Class	Switch Multilevel	GENERIC_TYPE_SWITCH_MULTILEVEL
Specific Device Class	Class A Motor Control	SPECIFIC_TYPE_CLASS_A_MOTOR_CONTROL

SUPPORTED COMMAND CLASS BY ENDPOINT

Informations below reported from Multi Channel Capability Report Command:

COMMAND CLASS	LIBRARY IDENTIFIER	VERSION
Binary	COMMAND_CLASS_SWITCH_BINARY	1
Multilevel Switch	COMMAND_CLASS_SWITCH_MULTILEVEL	4

DYNAMIC ENDPOINT EXPLANATION

Endpoints 1, 2, 3, set as "CURTAIN", are linked with endpoints 4, 5, 6 in vertical pairs, so endpoint 1 (direction up) is linked to endpoint 4 (direction down), and so on. Therefore endpoint 4, 5, 6, will not be "INTEROPERABLE" if a multichannel capability get is requested.

The valid endpoint association groups will be only 3, 4, 5. Relevant parameters are 191-196.

SPECIFICATIONS

Manufacturer ID: 0x010A

Models and Frequencies

REGION	CODE	FREQUENCY	PRODUCT TYPE ID	PRODUCT ID	APP ID
EU	02E02H011	868.4 Mhz	0x7115	0x1016	0x0215
IL	02EE20010	916 Mhz	0x7006	0x0F07	0x0106
KR	02EB2H010	921.4 Mhz	0x7116	0x1017	0x0216

Technical Specifications

Operating voltage	230 VAC 50 Hz
Consumption	<1.5W standby
Operating temperature	from 0°C to +40°C
Operating Humidity	20% - 90% RH non condensing
Storage temperature	from -40°C to +55°C
Storage Humidity	10% - 93% RH non condensing
IP Class	IP20
Package Dimension (W x H x D)	135 x 50 x 170 mm
Weight	~210 gr
RF radiated powered	2.5 mW (max)
RF range	Up to 40 m open range
Warranty	1 year

INSTALLATION

Wire the device according to the schematic below.

L Power connection (LIVE)
N Power connection (Neutral)

Position the device in the wall's mounting box and check cables are not interfering with the device case. Using the appropriate screw set that matches the wall box, fix the device in place without applying unnecessary torque to fixing screws.

Choosing a suitable location

Do not locate the device facing direct sunlight, humid or dusty place. The suitable ambient temperature is listed in specification.

Do not locate the device where there are any combustible substances or sources of heat (e.g. fires, radiators, boiler, etc.).

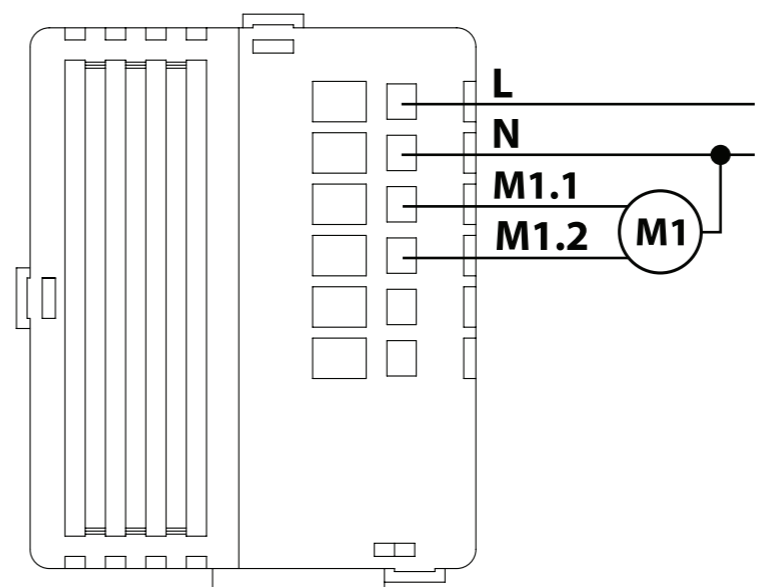

FUNCTIONS

Buttons and LEDs are numbered according the picture below facing front the device.

Each button has an RGB back-light LED that shows different colours during normal operation and certain sequence are also used to report special status.

Button #1 is used as **z-wave network button**

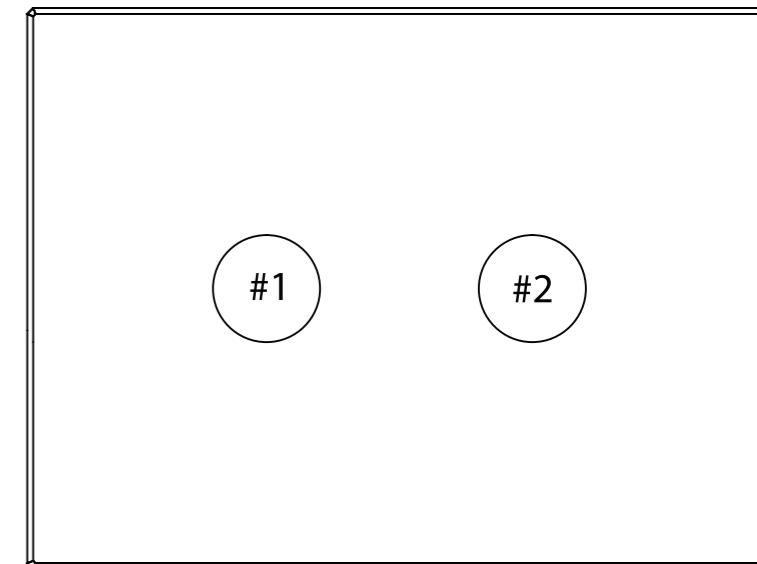

Special condition or status

LED	Colour codes	Description
LED #1	<i>blinks green for 5s</i>	<i>Valid HW signature detected at boot</i>
	<i>blinks red for 5s</i>	<i>Invalid HW signature detected at boot</i>
	<i>red glitch</i>	<i>When button #1 is touched indicates device is NOT included in the Z-Wave network</i>
	<i>Steady red</i>	<i>HW fault, contact assistance</i>

Normal operating condition or status

LED	Colour codes	Description
Any LED	<i>Steady blue</i>	<i>BASIC off or MULTILEVEL 0%</i>
	<i>Steady green</i>	<i>light dimming MULTILEVEL set at 33%</i>
	<i>Steady yellow</i>	<i>MULTILEVEL set at 100% or BASIC on</i>
	<i>Steady magenta</i>	<i>MOTOR control</i>

STANDARDS AND REGULATIONS

Electrical safety	(LVD) 2014/35/EU
Electromagnetic compatibility	(EMC) 2014/30/EU
Radio	(RED) 2014/53/EU
Presence of hazardous substances	(RoHS II) 2011/65/EU
Waste electrical and electronic equipment	(WEEE) 2012/19/EU

List of harmonized regulations applied

EN 301 489-1 V1.9.2; EN 301 489-3 V1.6.1
EN 50491-5-1:2010; EN 50491-5-2:2010
EN 60669-1:2000; EN 60669-1/A1:2003; EN60669-1/A2:2009
EN 60669-2-1:2004; EN 60669-2-1/A1:2009; EN 60669-2-1/A12:2009
EN 62479: 2010
EN 300 220-2 V.2.4.1



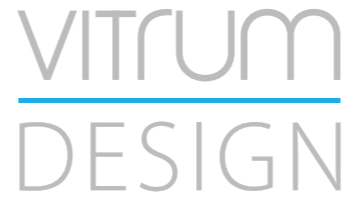

Model: WallZ-503
Type: 2CH-2RL
Code: 3M-01E02H020 4M- 01Q02H020
Protocol: Z-Wave Plus

INTRODUCTION

Purpose of this document

This manual describes the most essential functions and technical specifications to help the electrician to install, setup and control the device. It is a Z-Wave Plus device of the Vitrum 2.0 product range. Visit our website for the complete list.

This document is also available on our web-site.

Notice

Dispose cardboard box & holder, plastic bags and front plastic shell according to local recycling regulation. Box and holder are PAP recyclable, plastic bags are LDPE, front shell is PP.

Safety

Take care of your safety. Use only insulated tools and remove power from the mains circuit breakers before and during any installation activity.

Caution

This device is a permanently connected to the mains thus implies it is mandatory to have a readily accessible disconnect device (like a circuit breaker) incorporated in the general wiring of the building with at least 3mm separation between contacts.

Danger: Risk of electrocution

Device installation and maintenance must be carried out by trained and skilled electricians in accordance with local wiring and building regulations. The device has no basic insulation and must never be used without the front glass plate. It must be installed in a way that protect from accidental contact. During installation procedure, the dummy plastic cover must be left on.

Before and during installation disconnect mains power.

Before you start

You will need available and ready to use:

- Small Phillips isolated screw driver
- Small slotted isolated driver (alternate)

Package content

- 1 x Wall mountable device
- 2 x Metric screw set
- 2 x Plastic screw set
- 1 x Protective shell

Preparation

Remove carefully the device from the cardboard support. Keep this manual for further reference.

Features

Touch operated button with RGB back-light.
 Based on Z-Wave[®] 500 module for wider coverage and higher data rate.
 Very low power consumption in standby.
 Easy installation.
 Acoustic feedback at button press.
 Over-the-air firmware update.

Z-WAVE NETWORKING

This product can be included and operates in any Z-Wave network with other Z-Wave certified devices from other manufacturers and/or other applications. This device is an always powered node and within the network will act as repeater regardless of vendor to increase reliability of the network.

ADD (inclusion)

The device supports both Normal Inclusion and Network Wide Inclusion.

Follow the steps below to include the device into the network:

1. Check the device is not already included in a Z-Wave network by pressing any button on the front panel: the LED button should blink with red colour shortly. Should the device be already included, follow the instructions below to excluded it from the network.
2. Set the controller into "Inclusion Mode". Refer to the controller documentation to set the controller into Inclusion mode.
3. Set the device into Learn Mode by pressing and holding button No.1 (on the top left of the device) for longer than 4 seconds. The device will enter into inclusion mode by blinking magenta LED button No.1. Upon successful completion, the device LEDs will blink green three times.
4. Should for any reasons the device fail the normal inclusion, the device turns to enter into the Network Wide Inclusion Mode up to 4 times. Any time the device enters into Wide Inclusion Mode, LED Button No.1 blinks Magenta.

REMOVE (exclusion)

Before starting to exclude the device from the network set the controller into "Exclusion Mode". Please refer to the controller documentation to set the controller into Exclusion mode.

The device can be excluded from a network only if previously included. Check that by pressing a button on the front panel: the LED button should not blink with red colour shortly.

Follow the steps below to exclude the device from the network:

1. Press and hold button No.1 (on the top left of the front panel device) for around 6 seconds and after that press 3 times the same button shortly within 3 seconds.
2. LED Button No.1 blinks red upon completely the device exclusion successfully.
3. Check the device is removed from the network by pressing button No.1: the LED button blinks red shortly.

Node Info Frame

To send a Node info frame press and release shortly the *HIDDEN BUTTON* (see picture on Installation paragraph) on the front end top-back of the device; a short audio signal (*beep*), will confirm the Node Info transmission.

If parameter 217 is set at 1 or 2 (see parameter table below), each button send a "Multichannel Capability Report". As default, parameter 217 is OFF.

Firmware Update

This device supports the firmware update which can be started from any certified Z-Wave controller supporting the Firmware Update Command Class version 3 and above. While updating the device works normally.

Just when the firmware update completes, the device will be inactive for few seconds during self-programming and rebooting.

During the reboot process, the local loads (if present) will be disengaged. Should the firmware update fail, the whole updating process must be re-started from the beginning.

The updating will last from 10 to 30 minutes depending on the network traffic condition.

Factory Default procedure

1. Start the factory default procedure by pressing and holding the hidden button on the front end top-back of the device till the buzzer plays a long beep (5 s).
2. Release the button and press it again till the buzzer plays a sequence of 3 short beeps.
3. The device will revert to its factory default settings, blinking all LED buttons and rebooting.

Do not disconnect the device from the power supply until reboot is completed.

Configuration and settings are restored to default values. "Home ID" and "Node ID" will be cleared as well.

ASSOCIATION/MULTICHANNEL ASSOCIATION

Association enables the device to control other nodes included in the same Z-Wave network for a maximum of **20 nodes** for **each button/group** with max **10 endpoints per Node**.

Group 1 Lifeline Notification

Max 20 associations available, Singlechannel or Multichannel.

Warning: In order to enable a controller to receive notifications with a endpoint source address from a Multichannel device, the controller must be associated to the lifeline group with the Multichannel association command class.

Example: if controller Node ID is 1, MULTICHANNEL ASSOCIATION must be set to the lifeline group 1 with controller nodeID(1) and endpoint(1)

Group 2 Reserved

Group 3 MAX_NODES_IN_GROUP 20

MAX_END_POINTS per Node: 10

Single channel association is only for root device so if used in a Multichannel environment the source and destination endpoint are lost.

Multichannel Association instead contains the Source Endpoint and the Destination Endpoint so the device is addressed correctly.

General Rule for Groups

Each button has a dedicated group starting from #3 so button #1 is referred to **Group 3**, button #2 will control all the devices associated into group number 4 and so on. The number of groups depends on the number of endpoints (buttons). See table below for group association to buttons.

Messages sent by each group to associated devices are related to the "configuration type" of the endpoints.

Group N.	Button N.	Notes
1	-	Lifeline
2	-	Reserved
3	1	Always present
4	2	If present
5	3	If present
6	4	If present
7	5	If present
8	6	If present

PARAMETERS LIST

All parameters depends on their SIZE value. Size can be different from the table below. Before placing a "parameter #, SET value", always ask for a "Parameter #, GET" to retrieve the correct SIZE dimension.

See table below for the complete list of Configuration command Class parameters for all Vitrum products.

Description	Par. N. (Dec)	Size (B)	Value range	Default value
EP Type Button				
EP Type Button N.1 to N.6	1 to 6	1	0-26	Depends on specific device
End Point Type values				
EP_OFF	0			
EP_DIMMER	1		CC SWITCH MULTILEVEL - see par 31 to 36	
EP_SWITCHBUTTON	2		CC BASIC - see par 31 to 36	
EP_PUSHBUTTON	3		CC BASIC - see par 31 to 36	
EP_CURTAIN_1 Button	4		motor control with 1 button	
EP_CURTAIN	5		motor control with 2 buttons	
EP_MASTER_OFF	15		TBC	
EP_CURTAIN_UP	27		motor only up	
EP_CURTAIN_DOWN	28		motor only down	
Button Off Color				
Button N.1 to N.6 Off Color status	7 to 12	1	0-7	3
Button On Color				

Description	Par. N. (Dec)	Size (B)	Value range	Default value
Button N.1 to N.6 On Color status	13 to 18	1	0-7	4
Button Eco Color				
Button N.1 to N.6 Eco Color status	19 to 24	1	0-7	2
Button On/Off/Eco Color values list				
LED_COLOR_OFF	0			
LED_COLOR_RED	1			
LED_COLOR_GREEN	2			
LED_COLOR_BLU	3			
LED_COLOR_YELLOW	4			
LED_COLOR_MAGENTA	5			
LED_COLOR_CYAN	6			
LED_COLOR_WHITE	7			

Button to Output Port connection

Output Port connected to Button N.1 to N.6	25 to 30	1	0-6	
Output Port				
Not connected to any port	0			
Output Port N.1 to N.6 connected to button	1 to 6			
Basic or Multilevel SET max value type	31 to 36	1	0 = 0x63 (100%) 1 = 0xFF (last level)	0: 0x63

Motors Control Time

Channel 0 to 2 Motor Control Time (s)	191 to 193	1		60 (60 s)
Channel 0 Motor Control Switch All behavior (*1)	194	1		0
Channel 1 Motor Control Switch All behavior	195	1		0
Channel 2 Motor Control Switch All behavior	196	1		0
Lifeline queue time delay: <i>Add some delay to lifeline notifications</i>	215	2	1= 10 mS 10=100 mS 100=1000 mS	
NWI Enable	216	1	1: NWI enabled, default 0: learn mode classic only	
Multichannel Capability Report notification: Endpoint presentation after multichannel transmission	217	1	0: disabled, default 1: low power 2: Full Power	
Keyboard Lock Outputs and back-light still working 1. Lifeline notification CCConfig[218, 1] If a locked button is pressed 2. Force unlock: triple press on button 1 as per inclusion process -> BIP... BIP-BIP	218	1	0: unlock 1: lock	0: unlock
Triac safe mode when an EP is transformed in to curtain the corresponding Triac is disabled (only for triac dev.)	221	1	0:unable 1:disable	N/A

Example of End Point Type values:

Button configured as EP_CENTRAL_SCENE. It sends through the Lifeline association group the "Central Scene Notification" commands. (CMD_Key_Pressed,CMD_Key_Released,CMD_Key_Held_Down). To set an EP_CENTRAL_SCENE use the Configuration command Class parameter 1->6, value 0x1A.

NODE CAPABILITIES

Basic, Generic and Specific Device Class

Informations below Reported from Node Information Frame (NIF)

NIF PARAMETER DESCRIPTOR	LIBRARY IDENTIFIER
Basic Device Class	BASIC_TYPE_ROUTING_SLAVE Routing Slave Enhanced 232
Generic Device Class	GENERIC_TYPE_SWITCH_BINARY
Specific Device Class	SPECIFIC_TYPE_POWER_SWITCH_BINARY

Command Classes

Informations below Reported from:

- Node Information Frame (NIF)
- Version CC, Version Get and Report commands

COMMAND CLASS	LIBRARY IDENTIFIER	VERSION
Z-Wave Plus Info	COMMAND_CLASS_ZWAVEPLUS_INFO	2
Version	COMMAND_CLASS_VERSION	2
Manufacturer Specific	COMMAND_CLASS_MANUFACTURER_SPECIFIC	2
Device Reset Locally	COMMAND_CLASS_DEVICE_RESET_LOCALLY	1
Powerlevel	COMMAND_CLASS_POWERLEVEL	1
Firmware Update Meta Data	COMMAND_CLASS_FIRMWARE_UPDATE_MD	4
Association	COMMAND_CLASS_ASSOCIATION	2
Multi Channel Association	COMMAND_CLASS_MULTI_CHANNEL_ASSOCIATION	3
AGI (Association Gorup Info)	COMMAND_CLASS_ASSOCIATION_GRP_INFO	1
Multi Channel	COMMAND_CLASS_MULTI_CHANNEL	4
Configuration	COMMAND_CLASS_CONFIGURATION	1
Manufacturer Proprietary	COMMAND_CLASS_MANUFACTURER_PROPRIETARY	1
Indicator	COMMAND_CLASS_INDICATOR	1
Node Name and Location	COMMAND_CLASS_NODE_NAMING	1
All Switch	COMMAND_CLASS_SWITCH_ALL	1

COMMAND CLASS MARK

Scene Activation	COMMAND_CLASS_SCENE_ACTIVATION	1
Central Scene	COMMAND_CLASS_CENTRAL_SCENE	1
Multilevel Switch	COMMAND_CLASS_SWITCH_MULTILEVEL	4
Binary Switch	COMMAND_CLASS_SWITCH_BINARY	1
Basic	COMMAND_CLASS_BASIC	1

Command Class Specification

COMMAND CLASS BASIC SET: MAX Value = [0x63 o 0xFF] -> [par31->36]
COMMAND CLASS INDICATOR values 0-7,0xFF

The version implemented is the #1 and may turn the device as a blinking indicator. The supported values are 0x00 (off/disable) or 0xFF (on/enable) and the field may carry valid values from 1 to 7.

0xFF: StartBlink(ALL_CHANNELS, YELLOW);
0x00: StopBlink(ALL_CHANNELS);

Valid values are:

1: white, 2: blue, 3: green, 4: cyan, 5: red, 6: magenta, 7: yellow

Timeout: ~60s

Generic and Specific Device Class by Curtain Endpoint

Informations below reported from Multi Channel Capability Report Command, valid if endpoint is set as "CURTAIN" only.

PARAMETER DESCRIPTOR	DESCRIPTION	LIBRARY IDENTIFIER
Generic Device Class	Switch Multilevel	GENERIC_TYPE_SWITCH_MULTILEVEL
Specific Device Class	Class A Motor Control	SPECIFIC_TYPE_CLASS_A_MOTOR_CONTROL

SUPPORTED COMMAND CLASS BY ENDPOINT

Informations below reported from Multi Channel Capability Report Command:

COMMAND CLASS	LIBRARY IDENTIFIER	VERSION
Binary	COMMAND_CLASS_SWITCH_BINARY	1
Multilevel Switch	COMMAND_CLASS_SWITCH_MULTILEVEL	4

DYNAMIC ENDPOINT EXPLANATION

Endpoints 1, 2, 3, set as "CURTAIN", are linked with endpoints 4, 5, 6 in vertical pairs, so endpoint 1 (direction up) is linked to endpoint 4 (direction down), and so on. Therefore endpoint 4, 5, 6, will not be "INTEROPERABLE" if a multichannel capability get is requested.

The valid endpoint association groups will be only 3, 4, 5. Relevant parameters are 191-196.

SPECIFICATIONS

Manufacturer ID: 0x010A

Models and Frequencies

REGION	CODE	FREQUENCY	PRODUCT TYPE ID	PRODUCT ID	APP ID
EU ^{3M}	01E02H020	868.4 Mhz	0x7115	0x1016	0x0215
IL	01EE20020	916 Mhz	0x7006	0x0F07	0x0106
KR	01EB2H020	921.4 Mhz	0x7116	0x1017	0x0216

Technical Specifications

Operating voltage	230 VAC 50 Hz
Consumption	<1.5W standby
Operating temperature	from 0°C to +40°C
Operating Humidity	20% - 90% RH non condensing
Storage temperature	from -40°C to +55°C
Storage Humidity	10% - 93% RH non condensing
IP Class	IP20
Package Dimension (W x H x D)	135 x 50 x 170 mm
Weight	~210 gr
RF radiated powered	2.5 mW (max)
RF range	Up to 40 m open range
Warranty	1 year

INSTALLATION

Wire the device according to the schematic below.

- L Power connection (LIVE)
- N Power connection (Neutral)

Position the device in the wall's mounting box and check cables are not interfering with the device case. Using the appropriate screw set that matches the wall box, fix the device in place without applying unnecessary torque to fixing screws.

Choosing a suitable location

Do not locate the device facing direct sunlight, humid or dusty place. The suitable ambient temperature is listed in specification.

Do not locate the device where there are any combustible substances or sources of heat (e.g. fires, radiators, boiler, etc.).

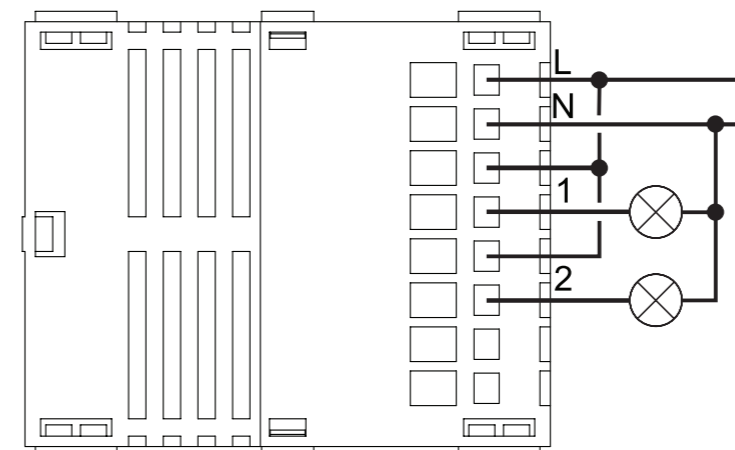

FUNCTIONS

Buttons and LEDs are numbered according the picture below facing front the device.

Each button has an RGB back-light LED that shows different colours during normal operation and certain sequence are also used to report special status.

Button #1 is used as **z-wave network button**

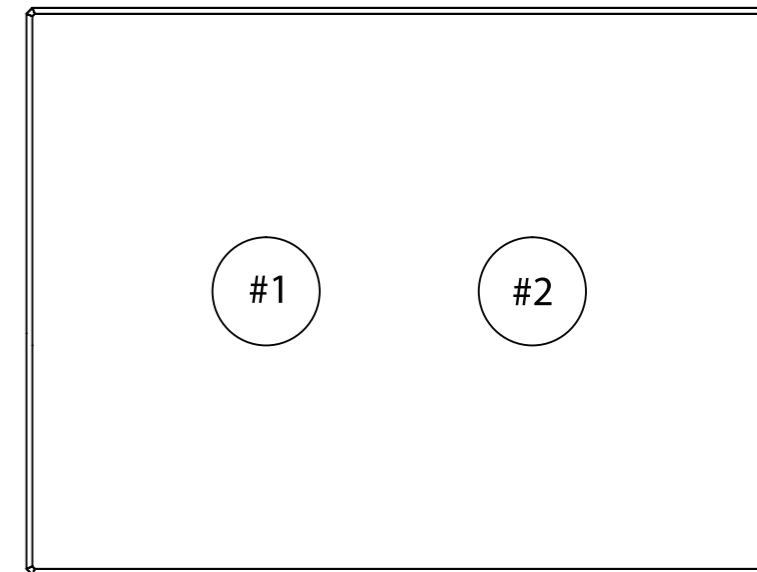

Special condition or status

LED	Colour codes	Description
LED #1	<i>blinks green for 5s</i>	<i>Valid HW signature detected at boot</i>
	<i>blinks red for 5s</i>	<i>Invalid HW signature detected at boot</i>
	<i>red glitch</i>	<i>When button #1 is touched indicates device is NOT included in the Z-Wave network</i>
	<i>Steady red</i>	<i>HW fault, contact assistance</i>

Normal operating condition or status

LED	Colour codes	Description
Any LED	<i>Steady blue</i>	<i>BASIC off or MULTILEVEL 0%</i>
	<i>Steady green</i>	<i>light dimming MULTILEVEL set at 33%</i>
	<i>Steady yellow</i>	<i>MULTILEVEL set at 100% or BASIC on</i>
	<i>Steady magenta</i>	<i>MOTOR control</i>

STANDARDS AND REGULATIONS

Electrical safety	(LVD) 2014/35/EU
Electromagnetic compatibility	(EMC) 2014/30/EU
Radio	(RED) 2014/53/EU
Presence of hazardous substances	(RoHS II) 2011/65/EU
Waste electrical and electronic equipment	(WEEE) 2012/19/EU

List of harmonized regulations applied

EN 301 489-1 V1.9.2; EN 301 489-3 V1.6.1
EN 50491-5-1:2010; EN 50491-5-2:2010
EN 60669-1:2000; EN 60669-1/A1:2003; EN60669-1/A2:2009
EN 60669-2-1:2004; EN 60669-2-1/A1:2009; EN 60669-2-1/A12:2009
EN 62479: 2010
EN 300 220-2 V.2.4.1





Model: WallZ-503
Type: 3CH-3RL
Code: 3M- 01E03H020 4M-01Q03H020
Protocol: Z-Wave Plus

INTRODUCTION

Purpose of this document

This manual describes the most essential functions and technical specifications to help the electrician to install, setup and control the device. It is a Z-Wave Plus device of the Vitrum 2.0 product range. Visit our website for the complete list.

This document is also available on our web-site.

Notice

Dispose cardboard box & holder, plastic bags and front plastic shell according to local recycling regulation. Box and holder are PAP recyclable, plastic bags are LDPE, front shell is PP.

Safety

Take care of your safety. Use only insulated tools and remove power from the mains circuit breakers before and during any installation activity.

Caution

This device is a permanently connected to the mains thus implies it is mandatory to have a readily accessible disconnect device (like a circuit breaker) incorporated in the general wiring of the building with at least 3mm separation between contacts.

Danger: Risk of electrocution

Device installation and maintenance must be carried out by trained and skilled electricians in accordance with local wiring and building regulations. The device has no basic insulation and must never be used without the front glass plate. It must be installed in a way that protect from accidental contact. During installation procedure, the dummy plastic cover must be left on.

Before and during installation disconnect mains power.

Before you start

You will need available and ready to use:

- Small Phillips isolated screw driver
- Small slotted isolated driver (alternate)

Package content

- 1 x Wall mountable device
- 2 x Metric screw set
- 2 x Plastic screw set
- 1 x Protective shell

Preparation

Remove carefully the device from the cardboard support. Keep this manual for further reference.

Features

Touch operated button with RGB back-light.
 Based on Z-Wave[®] 500 module for wider coverage and higher data rate.
 Very low power consumption in standby.
 Easy installation.
 Acoustic feedback at button press.
 Over-the-air firmware update.

Z-WAVE NETWORKING

This product can be included and operates in any Z-Wave network with other Z-Wave certified devices from other manufacturers and/or other applications. This device is an always powered node and within the network will act as repeater regardless of vendor to increase reliability of the network.

ADD (inclusion)

The device supports both Normal Inclusion and Network Wide Inclusion.

Follow the steps below to include the device into the network:

1. Check the device is not already included in a Z-Wave network by pressing any button on the front panel: the LED button should blink with red colour shortly. Should the device be already included, follow the instructions below to excluded it from the network.
2. Set the controller into "Inclusion Mode". Refer to the controller documentation to set the controller into Inclusion mode.
3. Set the device into Learn Mode by pressing and holding button No.1 (on the top left of the device) for longer than 4 seconds. The device will enter into inclusion mode by blinking magenta LED button No.1. Upon successful completion, the device LEDs will blink green three times.
4. Should for any reasons the device fail the normal inclusion, the device turns to enter into the Network Wide Inclusion Mode up to 4 times. Any time the device enters into Wide Inclusion Mode, LED Button No.1 blinks Magenta.

REMOVE (exclusion)

Before starting to exclude the device from the network set the controller into "Exclusion Mode". Please refer to the controller documentation to set the controller into Exclusion mode.

The device can be excluded from a network only if previously included. Check that by pressing a button on the front panel: the LED button should not blink with red colour shortly.

Follow the steps below to exclude the device from the network:

1. Press and hold button No.1 (on the top left of the front panel device) for around 6 seconds and after that press 3 times the same button shortly within 3 seconds.
2. LED Button No.1 blinks red upon completely the device exclusion successfully.
3. Check the device is removed from the network by pressing button No.1: the LED button blinks red shortly.

Node Info Frame

To send a Node info frame press and release shortly the *HIDDEN BUTTON* (see picture on Installation paragraph) on the front end top-back of the device; a short audio signal (*beep*), will confirm the Node Info transmission.

If parameter 217 is set at 1 or 2 (see parameter table below), each button send a "Multichannel Capability Report". As default, parameter 217 is OFF.

Firmware Update

This device supports the firmware update which can be started from any certified Z-Wave controller supporting the Firmware Update Command Class version 3 and above. While updating the device works normally.

Just when the firmware update completes, the device will be inactive for few seconds during self-programming and rebooting.

During the reboot process, the local loads (if present) will be disengaged. Should the firmware update fail, the whole updating process must be re-started from the beginning.

The updating will last from 10 to 30 minutes depending on the network traffic condition.

Factory Default procedure

1. Start the factory default procedure by pressing and holding the hidden button on the front end top-back of the device till the buzzer plays a long beep (5 s).
2. Release the button and press it again till the buzzer plays a sequence of 3 short beeps.
3. The device will revert to its factory default settings, blinking all LED buttons and rebooting.

Do not disconnect the device from the power supply until reboot is completed.

Configuration and settings are restored to default values. "Home ID" and "Node ID" will be cleared as well.

ASSOCIATION/MULTICHANNEL ASSOCIATION

Association enables the device to control other nodes included in the same Z-Wave network for a maximum of **20 nodes** for **each button/group** with max **10 endpoints per Node**.

Group 1 Lifeline Notification

Max 20 associations available, Singlechannel or Multichannel.

Warning: In order to enable a controller to receive notifications with a endpoint source address from a Multichannel device, the controller must be associated to the lifeline group with the Multichannel association command class.

Example: if controller Node ID is 1, MULTICHANNEL ASSOCIATION must be set to the lifeline group 1 with controller nodeID(1) and endpoint(1)

Group 2 Reserved

Group 3 MAX_NODES_IN_GROUP 20

MAX_END_POINTS per Node: 10

Single channel association is only for root device so if used in a Multichannel environment the source and destination endpoint are lost. Multichannel Association instead contains the Source Endpoint and the Destination Endpoint so the device is addressed correctly.

General Rule for Groups

Each button has a dedicated group starting from #3 so button #1 is referred to **Group 3**, button #2 will control all the devices associated into group number 4 and so on. The number of groups depends on the number of endpoints (buttons). See table below for group association to buttons.

Messages sent by each group to associated devices are related to the "configuration type" of the endpoints.

Group N.	Button N.	Notes
1	-	Lifeline
2	-	Reserved
3	1	Always present
4	2	If present
5	3	If present
6	4	If present
7	5	If present
8	6	If present

PARAMETERS LIST

All parameters depends on their SIZE value. Size can be different from the table below. Before placing a "parameter #, SET value", always ask for a "Parameter #, GET" to retrieve the correct SIZE dimension.

See table below for the complete list of Configuration command Class parameters for all Vitrum products.

Description	Par. N. (Dec)	Size (B)	Value range	Default value
EP Type Button				
EP Type Button N.1 to N.6	1 to 6	1	0-26	Depends on specific device
End Point Type values				
EP_OFF	0			
EP_DIMMER	1		CC SWITCH MULTILEVEL - see par 31 to 36	
EP_SWITCHBUTTON	2		CC BASIC - see par 31 to 36	
EP_PUSHBUTTON	3		CC BASIC - see par 31 to 36	
EP_CURTAIN_1 Button	4		motor control with 1 button	
EP_CURTAIN	5		motor control with 2 buttons	
EP_MASTER_OFF	15		TBC	
EP_CURTAIN_UP	27		motor only up	
EP_CURTAIN_DOWN	28		motor only down	
Button Off Color				
Button N.1 to N.6 Off Color status	7 to 12	1	0-7	3
Button On Color				

Description	Par. N. (Dec)	Size (B)	Value range	Default value
Button N.1 to N.6 On Color status	13 to 18	1	0-7	4
Button Eco Color				
Button N.1 to N.6 Eco Color status	19 to 24	1	0-7	2
Button On/Off/Eco Color values list				
LED_COLOR_OFF	0			
LED_COLOR_RED	1			
LED_COLOR_GREEN	2			
LED_COLOR_BLU	3			
LED_COLOR_YELLOW	4			
LED_COLOR_MAGENTA	5			
LED_COLOR_CYAN	6			
LED_COLOR_WHITE	7			

Button to Output Port connection

Output Port connected to Button N.1 to N.6	25 to 30	1	0-6	
Output Port				
Not connected to any port	0			
Output Port N.1 to N.6 connected to button	1 to 6			
Basic or Multilevel SET max value type	31 to 36	1	0 = 0x63 (100%) 1 = 0xFF (last level)	0: 0x63

Motors Control Time

Channel 0 to 2 Motor Control Time (s)	191 to 193	1		60 (60 s)
Channel 0 Motor Control Switch All behavior (*1)	194	1		0
Channel 1 Motor Control Switch All behavior	195	1		0
Channel 2 Motor Control Switch All behavior	196	1		0
Lifeline queue time delay: <i>Add some delay to lifeline notifications</i>	215	2	1= 10 mS 10=100 mS 100=1000 mS	
NWI Enable	216	1	1: NWI enabled, default 0: learn mode classic only	
Multichannel Capability Report notification: Endpoint presentation after multichannel transmission	217	1	0: disabled, default 1: low power 2: Full Power	
Keyboard Lock Outputs and back-light still working 1. Lifeline notification CCConfig[218, 1] If a locked button is pressed 2. Force unlock: triple press on button 1 as per inclusion process -> BIP... BIP-BIP	218	1	0: unlock 1: lock	0: unlock
Triac safe mode when an EP is transformed in to curtain the corresponding Triac is disabled (only for triac dev.)	221	1	0:unable 1:disable	N/A

Example of End Point Type values:

Button configured as EP_CENTRAL_SCENE. It sends through the Lifeline association group the "Central Scene Notification" commands. (CMD_Key_Pressed, CMD_Key_Released, CMD_Key_Held_Down). To set an EP_CENTRAL_SCENE use the Configuration command Class parameter 1->6, value 0x1A.

NODE CAPABILITIES

Basic, Generic and Specific Device Class

Informations below Reported from Node Information Frame (NIF)

NIF PARAMETER DESCRIPTOR	LIBRARY IDENTIFIER
Basic Device Class	BASIC_TYPE_ROUTING_SLAVE Routing Slave Enhanced 232
Generic Device Class	GENERIC_TYPE_SWITCH_BINARY
Specific Device Class	SPECIFIC_TYPE_POWER_SWITCH_BINARY

Command Classes

Informations below Reported from:

- Node Information Frame (NIF)
- Version CC, Version Get and Report commands

COMMAND CLASS	LIBRARY IDENTIFIER	VERSION
Z-Wave Plus Info	COMMAND_CLASS_ZWAVEPLUS_INFO	2
Version	COMMAND_CLASS_VERSION	2
Manufacturer Specific	COMMAND_CLASS_MANUFACTURER_SPECIFIC	2
Device Reset Locally	COMMAND_CLASS_DEVICE_RESET_LOCALLY	1
Powerlevel	COMMAND_CLASS_POWERLEVEL	1
Firmware Update Meta Data	COMMAND_CLASS_FIRMWARE_UPDATE_MD	4
Association	COMMAND_CLASS_ASSOCIATION	2
Multi Channel Association	COMMAND_CLASS_MULTI_CHANNEL_ASSOCIATION	3
AGI (Association Gorup Info)	COMMAND_CLASS_ASSOCIATION_GRP_INFO	1
Multi Channel	COMMAND_CLASS_MULTI_CHANNEL	4
Configuration	COMMAND_CLASS_CONFIGURATION	1
Manufacturer Proprietary	COMMAND_CLASS_MANUFACTURER_PROPRIETARY	1
Indicator	COMMAND_CLASS_INDICATOR	1
Node Name and Location	COMMAND_CLASS_NODE_NAMING	1
All Switch	COMMAND_CLASS_SWITCH_ALL	1

COMMAND CLASS MARK

Scene Activation	COMMAND_CLASS_SCENE_ACTIVATION	1
Central Scene	COMMAND_CLASS_CENTRAL_SCENE	1
Multilevel Switch	COMMAND_CLASS_SWITCH_MULTILEVEL	4
Binary Switch	COMMAND_CLASS_SWITCH_BINARY	1
Basic	COMMAND_CLASS_BASIC	1

Command Class Specification

COMMAND CLASS BASIC SET: MAX Value = [0x63 o 0xFF] -> [par31->36]
COMMAND CLASS INDICATOR values 0-7,0xFF

The version implemented is the #1 and may turn the device as a blinking indicator. The supported values are 0x00 (off/disable) or 0xFF (on/enable) and the field may carry valid values from 1 to 7.

0xFF: StartBlink(ALL_CHANNELS, YELLOW);
0x00: StopBlink(ALL_CHANNELS);

Valid values are:

1: white, 2: blue, 3: green, 4: cyan, 5: red, 6: magenta, 7: yellow

Timeout: ~60s

Generic and Specific Device Class by Curtain Endpoint

Informations below reported from Multi Channel Capability Report Command, valid if endpoint is set as "CURTAIN" only.

PARAMETER DESCRIPTOR	DESCRIPTION	LIBRARY IDENTIFIER
Generic Device Class	Switch Multilevel	GENERIC_TYPE_SWITCH_MULTILEVEL
Specific Device Class	Class A Motor Control	SPECIFIC_TYPE_CLASS_A_MOTOR_CONTROL

SUPPORTED COMMAND CLASS BY ENDPOINT

Informations below reported from Multi Channel Capability Report Command:

COMMAND CLASS	LIBRARY IDENTIFIER	VERSION
Binary	COMMAND_CLASS_SWITCH_BINARY	1
Multilevel Switch	COMMAND_CLASS_SWITCH_MULTILEVEL	4

DYNAMIC ENDPOINT EXPLANATION

Endpoints 1, 2, 3, set as "CURTAIN", are linked with endpoints 4, 5, 6 in vertical pairs, so endpoint 1 (direction up) is linked to endpoint 4 (direction down), and so on. Therefore endpoint 4, 5, 6, will not be "INTEROPERABLE" if a multichannel capability get is requested.

The valid endpoint association groups will be only 3, 4, 5. Relevant parameters are 191-196.

SPECIFICATIONS

Manufacturer ID: 0x010A

Models and Frequencies

REGION	CODE	FREQUENCY	PRODUCT TYPE ID	PRODUCT ID	APP ID
EU ^{3M}	01E03H020	868.4 Mhz	0x7115	0x1016	0x0215
IL	01EE30020	916 Mhz	0x7006	0x0F07	0x0106
KR	01EB3H020	921.4 Mhz	0x7116	0x1017	0x0216

Technical Specifications

Operating voltage	230 VAC 50 Hz
Consumption	<1.5W standby
Operating temperature	from 0°C to +40°C
Operating Humidity	20% - 90% RH non condensing
Storage temperature	from -40°C to +55°C
Storage Humidity	10% - 93% RH non condensing
IP Class	IP20
Package Dimension (W x H x D)	135 x 50 x 170 mm
Weight	~210 gr
RF radiated powered	2.5 mW (max)
RF range	Up to 40 m open range
Warranty	1 year

INSTALLATION

Wire the device according to the schematic below.

- L Power connection (LIVE)
- N Power connection (Neutral)

Position the device in the wall's mounting box and check cables are not interfering with the device case. Using the appropriate screw set that matches the wall box, fix the device in place without applying unnecessary torque to fixing screws.

Choosing a suitable location

Do not locate the device facing direct sunlight, humid or dusty place. The suitable ambient temperature is listed in specification.

Do not locate the device where there are any combustible substances or sources of heat (e.g. fires, radiators, boiler, etc.).

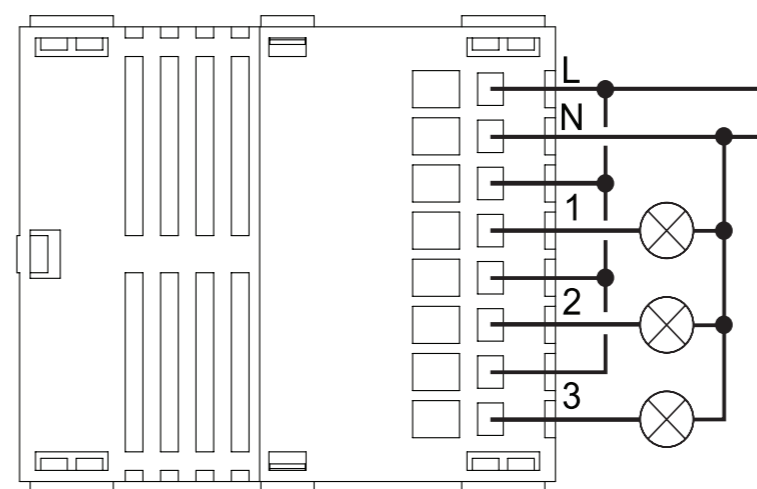

FUNCTIONS

Buttons and LEDs are numbered according the picture below facing front the device.

Each button has an RGB back-light LED that shows different colours during normal operation and certain sequence are also used to report special status.

Button #1 is used as **z-wave network button**

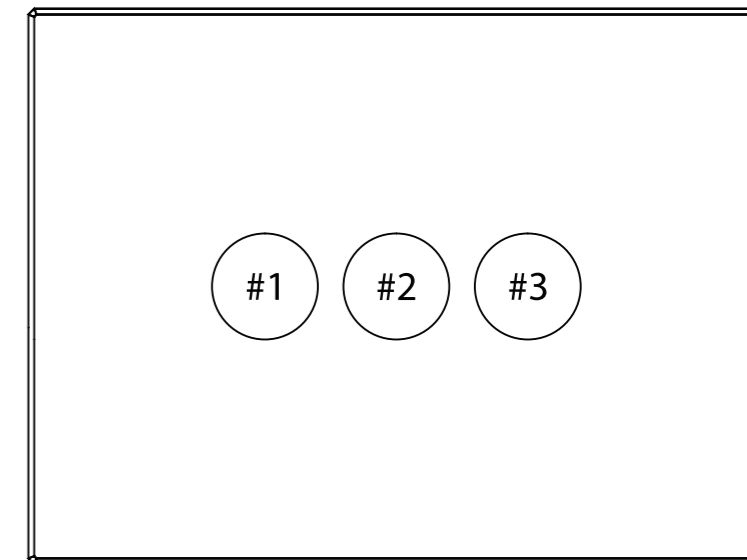

Special condition or status

LED	Colour codes	Description
LED #1	<i>blinks green for 5s</i>	<i>Valid HW signature detected at boot</i>
	<i>blinks red for 5s</i>	<i>Invalid HW signature detected at boot</i>
	<i>red glitch</i>	<i>When button #1 is touched indicates device is NOT included in the Z-Wave network</i>
	<i>Steady red</i>	<i>HW fault, contact assistance</i>

Normal operating condition or status

LED	Colour codes	Description
Any LED	<i>Steady blue</i>	<i>BASIC off or MULTILEVEL 0%</i>
	<i>Steady green</i>	<i>light dimming MULTILEVEL set at 33%</i>
	<i>Steady yellow</i>	<i>MULTILEVEL set at 100% or BASIC on</i>
	<i>Steady magenta</i>	<i>MOTOR control</i>

STANDARDS AND REGULATIONS

Electrical safety	(LVD) 2014/35/EU
Electromagnetic compatibility	(EMC) 2014/30/EU
Radio	(RED) 2014/53/EU
Presence of hazardous substances	(RoHS II) 2011/65/EU
Waste electrical and electronic equipment	(WEEE) 2012/19/EU

List of harmonized regulations applied

EN 301 489-1 V1.9.2; EN 301 489-3 V1.6.1
EN 50491-5-1:2010; EN 50491-5-2:2010
EN 60669-1:2000; EN 60669-1/A1:2003; EN60669-1/A2:2009
EN 60669-2-1:2004; EN 60669-2-1/A1:2009; EN 60669-2-1/A12:2009
EN 62479: 2010
EN 300 220-2 V.2.4.1





Model: WallZ-503
Type: 4CH-4TR
Code: 3M-01E04H030 4M-01Q04H030
Protocol: Z-Wave Plus

INTRODUCTION

Purpose of this document

This manual describes the most essential functions and technical specifications to help the electrician to install, setup and control the device. It is a Z-Wave Plus device of the Vitrum 2.0 product range. Visit our website for the complete list.

This document is also available on our web-site.

Notice

Dispose cardboard box & holder, plastic bags and front plastic shell according to local recycling regulation. Box and holder are PAP recyclable, plastic bags are LDPE, front shell is PP.

Safety

Take care of your safety. Use only insulated tools and remove power from the mains circuit breakers before and during any installation activity.

Caution

This device is a permanently connected to the mains thus implies it is mandatory to have a readily accessible disconnect device (like a circuit breaker) incorporated in the general wiring of the building with at least 3mm separation between contacts.

Danger: Risk of electrocution

Device installation and maintenance must be carried out by trained and skilled electricians in accordance with local wiring and building regulations. The device has no basic insulation and must never be used without the front glass plate. It must be installed in a way that protect from accidental contact. During installation procedure, the dummy plastic cover must be left on.

Before and during installation disconnect mains power.

Before you start

You will need available and ready to use:

- Small Phillips isolated screw driver
- Small slotted isolated driver (alternate)

Package content

- 1 x Wall mountable device
- 2 x Metric screw set
- 2 x Plastic screw set
- 1 x Protective shell

Preparation

Remove carefully the device from the cardboard support. Keep this manual for further reference.

Features

Touch operated button with RGB back-light.
 Based on Z-Wave[®] 500 module for wider coverage and higher data rate.
 Very low power consumption in standby.
 Easy installation.
 Acoustic feedback at button press.
 Over-the-air firmware update.

Z-WAVE NETWORKING

This product can be included and operates in any Z-Wave network with other Z-Wave certified devices from other manufacturers and/or other applications. This device is an always powered node and within the network will act as repeater regardless of vendor to increase reliability of the network.

ADD (inclusion)

The device supports both Normal Inclusion and Network Wide Inclusion.

Follow the steps below to include the device into the network:

1. Check the device is not already included in a Z-Wave network by pressing any button on the front panel: the LED button should blink with red colour shortly. Should the device be already included, follow the instructions below to excluded it from the network.
2. Set the controller into "Inclusion Mode". Refer to the controller documentation to set the controller into Inclusion mode.
3. Set the device into Learn Mode by pressing and holding button No.1 (on the top left of the device) for longer than 4 seconds. The device will enter into inclusion mode by blinking magenta LED button No.1. Upon successful completion, the device LEDs will blink green three times.
4. Should for any reasons the device fail the normal inclusion, the device turns to enter into the Network Wide Inclusion Mode up to 4 times. Any time the device enters into Wide Inclusion Mode, LED Button No.1 blinks Magenta.

REMOVE (exclusion)

Before starting to exclude the device from the network set the controller into "Exclusion Mode". Please refer to the controller documentation to set the controller into Exclusion mode.

The device can be excluded from a network only if previously included. Check that by pressing a button on the front panel: the LED button should not blink with red colour shortly.

Follow the steps below to exclude the device from the network:

1. Press and hold button No.1 (on the top left of the front panel device) for around 6 seconds and after that press 3 times the same button shortly within 3 seconds.
2. LED Button No.1 blinks red upon completely the device exclusion successfully.
3. Check the device is removed from the network by pressing button No.1: the LED button blinks red shortly.

Node Info Frame

To send a Node info frame press and release shortly the *HIDDEN BUTTON* (see picture on Installation paragraph) on the front end top-back of the device; a short audio signal (*beep*), will confirm the Node Info transmission.

If parameter 217 is set at 1 or 2 (see parameter table below), each button send a "Multichannel Capability Report". As default, parameter 217 is OFF.

Firmware Update

This device supports the firmware update which can be started from any certified Z-Wave controller supporting the Firmware Update Command Class version 3 and above. While updating the device works normally.

Just when the firmware update completes, the device will be inactive for few seconds during self-programming and rebooting.

During the reboot process, the local loads (if present) will be disengaged. Should the firmware update fail, the whole updating process must be re-started from the beginning.

The updating will last from 10 to 30 minutes depending on the network traffic condition.

Factory Default procedure

1. Start the factory default procedure by pressing and holding the hidden button on the front end top-back of the device till the buzzer plays a long beep (5 s).
2. Release the button and press it again till the buzzer plays a sequence of 3 short beeps.
3. The device will revert to its factory default settings, blinking all LED buttons and rebooting.

Do not disconnect the device from the power supply until reboot is completed.

Configuration and settings are restored to default values. "Home ID" and "Node ID" will be cleared as well.

ASSOCIATION/MULTICHANNEL ASSOCIATION

Association enables the device to control other nodes included in the same Z-Wave network for a maximum of **20 nodes** for **each button/group** with max **10 endpoints per Node**.

Group 1 Lifeline Notification

Max 20 associations available, Singlechannel or Multichannel.

Warning: In order to enable a controller to receive notifications with a endpoint source address from a Multichannel device, the controller must be associated to the lifeline group with the Multichannel association command class.

Example: if controller Node ID is 1, MULTICHANNEL ASSOCIATION must be set to the lifeline group 1 with controller nodeID(1) and endpoint(1)

Group 2 Reserved

Group 3 MAX_NODES_IN_GROUP 20

MAX_END_POINTS per Node: 10

Single channel association is only for root device so if used in a Multichannel environment the source and destination endpoint are lost.

Multichannel Association instead contains the Source Endpoint and the Destination Endpoint so the device is addressed correctly.

General Rule for Groups

Each button has a dedicated group starting from #3 so button #1 is referred to **Group 3**, button #2 will control all the devices associated into group number 4 and so on. The number of groups depends on the number of endpoints (buttons). See table below for group association to buttons.

Messages sent by each group to associated devices are related to the "configuration type" of the endpoints.

Group N.	Button N.	Notes
1	-	Lifeline
2	-	Reserved
3	1	Always present
4	2	If present
5	3	If present
6	4	If present
7	5	If present
8	6	If present

PARAMETERS LIST

All parameters depends on their SIZE value. Size can be different from the table below. Before placing a "parameter #, SET value", always ask for a "Parameter #, GET" to retrieve the correct SIZE dimension.

See table below for the complete list of Configuration command Class parameters for all Vitrum products.

Description	Par. N. (Dec)	Size (B)	Value range	Default value
EP Type Button				
EP Type Button N.1 to N.6	1 to 6	1	0-26	Depends on specific device
End Point Type values				
EP_OFF	0			
EP_DIMMER	1		CC SWITCH MULTILEVEL - see par 31 to 36	
EP_SWITCHBUTTON	2		CC BASIC - see par 31 to 36	
EP_PUSHBUTTON	3		CC BASIC - see par 31 to 36	
EP_CURTAIN_1 Button	4		motor control with 1 button	
EP_CURTAIN	5		motor control with 2 buttons	
EP_MASTER_OFF	15		TBC	
EP_CURTAIN_UP	27		motor only up	
EP_CURTAIN_DOWN	28		motor only down	
Button Off Color				
Button N.1 to N.6 Off Color status	7 to 12	1	0-7	3
Button On Color				

Description	Par. N. (Dec)	Size (B)	Value range	Default value
Button N.1 to N.6 On Color status	13 to 18	1	0-7	4
Button Eco Color				
Button N.1 to N.6 Eco Color status	19 to 24	1	0-7	2
Button On/Off/Eco Color values list				
LED_COLOR_OFF	0			
LED_COLOR_RED	1			
LED_COLOR_GREEN	2			
LED_COLOR_BLU	3			
LED_COLOR_YELLOW	4			
LED_COLOR_MAGENTA	5			
LED_COLOR_CYAN	6			
LED_COLOR_WHITE	7			

Button to Output Port connection

Output Port connected to Button N.1 to N.6	25 to 30	1	0-6	
Output Port				
Not connected to any port	0			
Output Port N.1 to N.6 connected to button	1 to 6			
Basic or Multilevel SET max value type	31 to 36	1	0 = 0x63 (100%) 1 = 0xFF (last level)	0: 0x63

Motors Control Time

Channel 0 to 2 Motor Control Time (s)	191 to 193	1		60 (60 s)
Channel 0 Motor Control Switch All behavior (*1)	194	1		0
Channel 1 Motor Control Switch All behavior	195	1		0
Channel 2 Motor Control Switch All behavior	196	1		0
Lifeline queue time delay: <i>Add some delay to lifeline notifications</i>	215	2	1= 10 mS 10=100 mS 100=1000 mS	
NWI Enable	216	1	1: NWI enabled, default 0: learn mode classic only	
Multichannel Capability Report notification: Endpoint presentation after multichannel transmission	217	1	0: disabled, default 1: low power 2: Full Power	
Keyboard Lock Outputs and back-light still working 1. Lifeline notification CConfig[218, 1] If a locked button is pressed 2. Force unlock: triple press on button 1 as per inclusion process -> BIP... BIP-BIP	218	1	0: unlock 1: lock	0: unlock
Triac safe mode when an EP is transformed in to curtain the corresponding Triac is disabled (only for triac dev.)	221	1	0:unable 1:disable	N/A

Example of End Point Type values:

Button configured as EP_CENTRAL_SCENE. It sends through the Lifeline association group the "Central Scene Notification" commands. (CMD_Key_Pressed, CMD_Key_Released, CMD_Key_Held_Down). To set an EP_CENTRAL_SCENE use the Configuration command Class parameter 1->6, value 0x1A.

NODE CAPABILITIES

Basic, Generic and Specific Device Class

Informations below Reported from Node Information Frame (NIF)

NIF PARAMETER DESCRIPTOR	LIBRARY IDENTIFIER
Basic Device Class	BASIC_TYPE_ROUTING_SLAVE Routing Slave Enhanced 232
Generic Device Class	GENERIC_TYPE_SWITCH_BINARY
Specific Device Class	SPECIFIC_TYPE_POWER_SWITCH_BINARY

Command Classes

Informations below Reported from:

- Node Information Frame (NIF)
- Version CC, Version Get and Report commands

COMMAND CLASS	LIBRARY IDENTIFIER	VERSION
Z-Wave Plus Info	COMMAND_CLASS_ZWAVEPLUS_INFO	2
Version	COMMAND_CLASS_VERSION	2
Manufacturer Specific	COMMAND_CLASS_MANUFACTURER_SPECIFIC	2
Device Reset Locally	COMMAND_CLASS_DEVICE_RESET_LOCALLY	1
Powerlevel	COMMAND_CLASS_POWERLEVEL	1
Firmware Update Meta Data	COMMAND_CLASS_FIRMWARE_UPDATE_MD	4
Association	COMMAND_CLASS_ASSOCIATION	2
Multi Channel Association	COMMAND_CLASS_MULTI_CHANNEL_ASSOCIATION	3
AGI (Association Group Info)	COMMAND_CLASS_ASSOCIATION_GRP_INFO	1
Multi Channel	COMMAND_CLASS_MULTI_CHANNEL	4
Configuration	COMMAND_CLASS_CONFIGURATION	1
Manufacturer Proprietary	COMMAND_CLASS_MANUFACTURER_PROPRIETARY	1
Indicator	COMMAND_CLASS_INDICATOR	1
Node Name and Location	COMMAND_CLASS_NODE_NAMING	1
All Switch	COMMAND_CLASS_SWITCH_ALL	1

COMMAND CLASS MARK

Scene Activation	COMMAND_CLASS_SCENE_ACTIVATION	1
Central Scene	COMMAND_CLASS_CENTRAL_SCENE	1
Multilevel Switch	COMMAND_CLASS_SWITCH_MULTILEVEL	4
Binary Switch	COMMAND_CLASS_SWITCH_BINARY	1
Basic	COMMAND_CLASS_BASIC	1

Command Class Specification

COMMAND CLASS BASIC SET: MAX Value = [0x63 o 0xFF] -> [par31->36]
COMMAND CLASS INDICATOR values 0-7, 0xFF

The version implemented is the #1 and may turn the device as a blinking indicator. The supported values are 0x00 (off/disable) or 0xFF (on/enable) and the field may carry valid values from 1 to 7.

0xFF: StartBlink(ALL_CHANNELS, YELLOW);
0x00: StopBlink(ALL_CHANNELS);

Valid values are:

1: white, 2: blue, 3: green, 4: cyan, 5: red, 6: magenta, 7: yellow

Timeout: ~60s

Generic and Specific Device Class by Curtain Endpoint

Informations below reported from Multi Channel Capability Report Command, valid if endpoint is set as "CURTAIN" only.

PARAMETER DESCRIPTOR	DESCRIPTION	LIBRARY IDENTIFIER
Generic Device Class	Switch Multilevel	GENERIC_TYPE_SWITCH_MULTILEVEL
Specific Device Class	Class A Motor Control	SPECIFIC_TYPE_CLASS_A_MOTOR_CONTROL

SUPPORTED COMMAND CLASS BY ENDPOINT

Informations below reported from Multi Channel Capability Report Command:

COMMAND CLASS	LIBRARY IDENTIFIER	VERSION
Binary	COMMAND_CLASS_SWITCH_BINARY	1
Multilevel Switch	COMMAND_CLASS_SWITCH_MULTILEVEL	4

DYNAMIC ENDPOINT EXPLANATION

Endpoints 1, 2, 3, set as "CURTAIN", are linked with endpoints 4, 5, 6 in vertical pairs, so endpoint 1 (direction up) is linked to endpoint 4 (direction down), and so on. Therefore endpoint 4, 5, 6, will not be "INTEROPERABLE" if a multichannel capability get is requested.

The valid endpoint association groups will be only 3, 4, 5. Relevant parameters are 191-196.

SPECIFICATIONS

Manufacturer ID: 0x010A

Models and Frequencies

REGION	CODE	FREQUENCY	PRODUCT TYPE ID	PRODUCT ID	APP ID
EU	01E04H030	868.4 Mhz	0x7115	0x1016	0x0215
IL	01EE40030	916 Mhz	0x7006	0x0F07	0x0106
KR	01EB4H030	921.4 Mhz	0x7116	0x1017	0x0216

Technical Specifications

Operating voltage	230 VAC 50 Hz
Consumption	<1.5W standby
Operating temperature	from 0°C to +40°C
Operating Humidity	20% - 90% RH non condensing
Storage temperature	from -40°C to +55°C
Storage Humidity	10% - 93% RH non condensing
IP Class	IP20
Package Dimension (W x H x D)	135 x 50 x 170 mm
Weight	~210 gr
RF radiated powered	2.5 mW (max)
RF range	Up to 40 m open range
Warranty	1 year

INSTALLATION

Wire the device according to the schematic below.

L Power connection (LIVE)
N Power connection (Neutral)

Position the device in the wall's mounting box and check cables are not interfering with the device case. Using the appropriate screw set that matches the wall box, fix the device in place without applying unnecessary torque to fixing screws.

Choosing a suitable location

Do not locate the device facing direct sunlight, humid or dusty place. The suitable ambient temperature is listed in specification.

Do not locate the device where there are any combustible substances or sources of heat (e.g. fires, radiators, boiler, etc.).

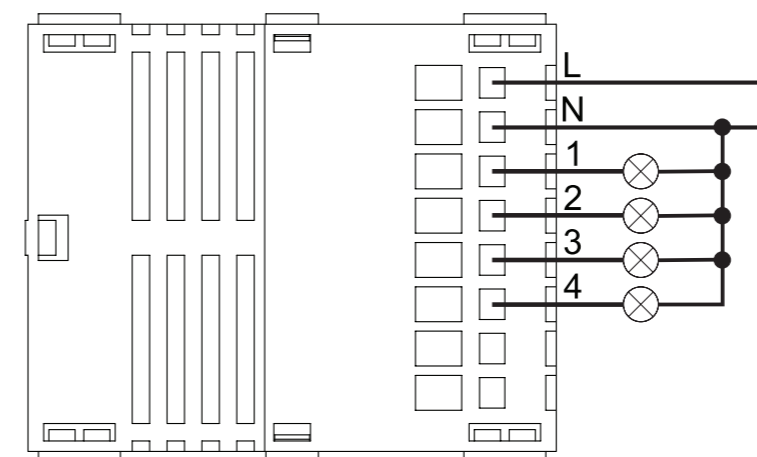

ATTENTION: need a protection relay, only when is used for motor

FUNCTIONS

Buttons and LEDs are numbered according the picture below facing front the device.

Each button has an RGB back-light LED that shows different colours during normal operation and certain sequence are also used to report special status.

Button #1 is used as **z-wave network button**

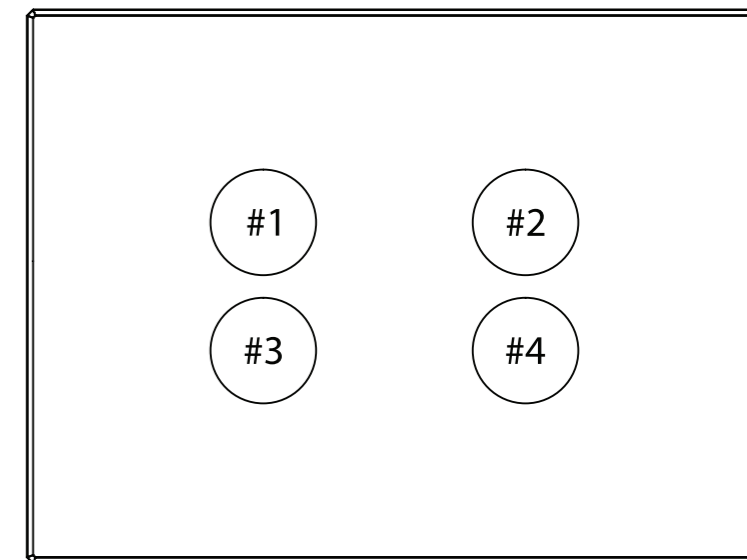

Special condition or status

LED	Colour codes	Description
LED #1	<i>blinks green for 5s</i>	<i>Valid HW signature detected at boot</i>
	<i>blinks red for 5s</i>	<i>Invalid HW signature detected at boot</i>
	<i>red glitch</i>	<i>When button #1 is touched indicates device is NOT included in the Z-Wave network</i>
	<i>Steady red</i>	<i>HW fault, contact assistance</i>

Normal operating condition or status

LED	Colour codes	Description
Any LED	<i>Steady blue</i>	<i>BASIC off or MULTILEVEL 0%</i>
	<i>Steady green</i>	<i>light dimming MULTILEVEL set at 33%</i>
	<i>Steady yellow</i>	<i>MULTILEVEL set at 100% or BASIC on</i>
	<i>Steady magenta</i>	<i>MOTOR control</i>

STANDARDS AND REGULATIONS

Electrical safety	(LVD) 2014/35/EU
Electromagnetic compatibility	(EMC) 2014/30/EU
Radio	(RED) 2014/53/EU
Presence of hazardous substances	(RoHS II) 2011/65/EU
Waste electrical and electronic equipment	(WEEE) 2012/19/EU

List of harmonized regulations applied

EN 301 489-1 V1.9.2; EN 301 489-3 V1.6.1
EN 50491-5-1:2010; EN 50491-5-2:2010
EN 60669-1:2000; EN 60669-1/A1:2003; EN60669-1/A2:2009
EN 60669-2-1:2004; EN 60669-2-1/A1:2009; EN 60669-2-1/A12:2009
EN 62479: 2010
EN 300 220-2 V.2.4.1



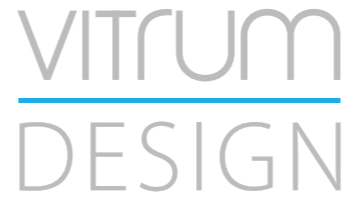

Model: WallZ-503
Type: 6CH-0
Code: 3M-01E06H041 4M- 01Q06H041
Protocol: Z-Wave Plus

INTRODUCTION

Purpose of this document

This manual describes the most essential functions and technical specifications to help the electrician to install, setup and control the device. It is a Z-Wave Plus device of the Vitrum 2.0 product range. Visit our website for the complete list.

This document is also available on our web-site.

Notice

Dispose cardboard box & holder, plastic bags and front plastic shell according to local recycling regulation. Box and holder are PAP recyclable, plastic bags are LDPE, front shell is PP.

Safety

Take care of your safety. Use only insulated tools and remove power from the mains circuit breakers before and during any installation activity.

Caution

This device is a permanently connected to the mains thus implies it is mandatory to have a readily accessible disconnect device (like a circuit breaker) incorporated in the general wiring of the building with at least 3mm separation between contacts.

Danger: Risk of electrocution

Device installation and maintenance must be carried out by trained and skilled electricians in accordance with local wiring and building regulations. The device has no basic insulation and must never be used without the front glass plate. It must be installed in a way that protect from accidental contact. During installation procedure, the dummy plastic cover must be left on.

Before and during installation disconnect mains power.

Before you start

You will need available and ready to use:

- Small Phillips isolated screw driver
- Small slotted isolated driver (alternate)

Package content

- 1 x Wall mountable device
- 2 x Metric screw set
- 2 x Plastic screw set
- 1 x Protective shell

Preparation

Remove carefully the device from the cardboard support. Keep this manual for further reference.

Features

Touch operated button with RGB back-light.
 Based on Z-Wave[®] 500 module for wider coverage and higher data rate.
 Very low power consumption in standby.
 Easy installation.
 Acoustic feedback at button press.
 Over-the-air firmware update.

Z-WAVE NETWORKING

This product can be included and operates in any Z-Wave network with other Z-Wave certified devices from other manufacturers and/or other applications. This device is an always powered node and within the network will act as repeater regardless of vendor to increase reliability of the network.

ADD (inclusion)

The device supports both Normal Inclusion and Network Wide Inclusion.

Follow the steps below to include the device into the network:

1. Check the device is not already included in a Z-Wave network by pressing any button on the front panel: the LED button should blink with red colour shortly. Should the device be already included, follow the instructions below to excluded it from the network.
2. Set the controller into "Inclusion Mode". Refer to the controller documentation to set the controller into Inclusion mode.
3. Set the device into Learn Mode by pressing and holding button No.1 (on the top left of the device) for longer than 4 seconds. The device will enter into inclusion mode by blinking magenta LED button No.1. Upon successful completion, the device LEDs will blink green three times.
4. Should for any reasons the device fail the normal inclusion, the device turns to enter into the Network Wide Inclusion Mode up to 4 times. Any time the device enters into Wide Inclusion Mode, LED Button No.1 blinks Magenta.

REMOVE (exclusion)

Before starting to exclude the device from the network set the controller into "Exclusion Mode". Please refer to the controller documentation to set the controller into Exclusion mode.

The device can be excluded from a network only if previously included. Check that by pressing a button on the front panel: the LED button should not blink with red colour shortly.

Follow the steps below to exclude the device from the network:

1. Press and hold button No.1 (on the top left of the front panel device) for around 6 seconds and after that press 3 times the same button shortly within 3 seconds.
2. LED Button No.1 blinks red upon completely the device exclusion successfully.
3. Check the device is removed from the network by pressing button No.1: the LED button blinks red shortly.

Node Info Frame

To send a Node info frame press and release shortly the *HIDDEN BUTTON* (see picture on Installation paragraph) on the front end top-back of the device; a short audio signal (*beep*), will confirm the Node Info transmission.

If parameter 217 is set at 1 or 2 (see parameter table below), each button send a "Multichannel Capability Report". As default, parameter 217 is OFF.

Firmware Update

This device supports the firmware update which can be started from any certified Z-Wave controller supporting the Firmware Update Command Class version 3 and above. While updating the device works normally.

Just when the firmware update completes, the device will be inactive for few seconds during self-programming and rebooting.

During the reboot process, the local loads (if present) will be disengaged. Should the firmware update fail, the whole updating process must be re-started from the beginning.

The updating will last from 10 to 30 minutes depending on the network traffic condition.

Factory Default procedure

1. Start the factory default procedure by pressing and holding the hidden button on the front end top-back of the device till the buzzer plays a long beep (5 s).
2. Release the button and press it again till the buzzer plays a sequence of 3 short beeps.
3. The device will revert to its factory default settings, blinking all LED buttons and rebooting.

Do not disconnect the device from the power supply until reboot is completed.

Configuration and settings are restored to default values. "Home ID" and "Node ID" will be cleared as well.

ASSOCIATION/MULTICHANNEL ASSOCIATION

Association enables the device to control other nodes included in the same Z-Wave network for a maximum of **20 nodes** for **each button/group** with max **10 endpoints per Node**.

Group 1 Lifeline Notification

Max 20 associations available, Singlechannel or Multichannel.

Warning: In order to enable a controller to receive notifications with a endpoint source address from a Multichannel device, the controller must be associated to the lifeline group with the Multichannel association command class.

Example: if controller Node ID is 1, MULTICHANNEL ASSOCIATION must be set to the lifeline group 1 with controller nodeID(1) and endpoint(1)

Group 2 Reserved

Group 3 MAX_NODES_IN_GROUP 20

MAX_END_POINTS per Node: 10

Single channel association is only for root device so if used in a Multichannel environment the source and destination endpoint are lost.

Multichannel Association instead contains the Source Endpoint and the Destination Endpoint so the device is addressed correctly.

General Rule for Groups

Each button has a dedicated group starting from #3 so button #1 is referred to **Group 3**, button #2 will control all the devices associated into group number 4 and so on. The number of groups depends on the number of endpoints (buttons). See table below for group association to buttons.

Messages sent by each group to associated devices are related to the "configuration type" of the endpoints.

Group N.	Button N.	Notes
1	-	Lifeline
2	-	Reserved
3	1	Always present
4	2	If present
5	3	If present
6	4	If present
7	5	If present
8	6	If present

PARAMETERS LIST

All parameters depends on their SIZE value. Size can be different from the table below. Before placing a "parameter #, SET value", always ask for a "Parameter #, GET" to retrieve the correct SIZE dimension.

See table below for the complete list of Configuration command Class parameters for all Vitrum products.

Description	Par. N. (Dec)	Size (B)	Value range	Default value
EP Type Button				
EP Type Button N.1 to N.6	1 to 6	1	0-26	Depends on specific device
End Point Type values				
EP_OFF	0			
EP_DIMMER	1		CC SWITCH MULTILEVEL - see par 31 to 36	
EP_SWITCHBUTTON	2		CC BASIC - see par 31 to 36	
EP_PUSHBUTTON	3		CC BASIC - see par 31 to 36	
EP_CURTAIN_1 Button	4		motor control with 1 button	
EP_CURTAIN	5		motor control with 2 buttons	
EP_MASTER_OFF	15		TBC	
EP_CURTAIN_UP	27		motor only up	
EP_CURTAIN_DOWN	28		motor only down	
Button Off Color				
Button N.1 to N.6 Off Color status	7 to 12	1	0-7	3
Button On Color				

Description	Par. N. (Dec)	Size (B)	Value range	Default value
Button N.1 to N.6 On Color status	13 to 18	1	0-7	4
Button Eco Color				
Button N.1 to N.6 Eco Color status	19 to 24	1	0-7	2
Button On/Off/Eco Color values list				
LED_COLOR_OFF	0			
LED_COLOR_RED	1			
LED_COLOR_GREEN	2			
LED_COLOR_BLU	3			
LED_COLOR_YELLOW	4			
LED_COLOR_MAGENTA	5			
LED_COLOR_CYAN	6			
LED_COLOR_WHITE	7			

Button to Output Port connection

Output Port connected to Button N.1 to N.6	25 to 30	1	0-6	
Output Port				
Not connected to any port	0			
Output Port N.1 to N.6 connected to button	1 to 6			
Basic or Multilevel SET max value type	31 to 36	1	0 = 0x63 (100%) 1 = 0xFF (last level)	0: 0x63

Motors Control Time

Channel 0 to 2 Motor Control Time (s)	191 to 193	1		60 (60 s)
Channel 0 Motor Control Switch All behavior (*1)	194	1		0
Channel 1 Motor Control Switch All behavior	195	1		0
Channel 2 Motor Control Switch All behavior	196	1		0
Lifeline queue time delay: <i>Add some delay to lifeline notifications</i>	215	2	1= 10 mS 10=100 mS 100=1000 mS	
NWI Enable	216	1	1: NWI enabled, default 0: learn mode classic only	
Multichannel Capability Report notification: Endpoint presentation after multichannel transmission	217	1	0: disabled, default 1: low power 2: Full Power	
Keyboard Lock Outputs and back-light still working 1. Lifeline notification CConfig[218, 1] If a locked button is pressed 2. Force unlock: triple press on button 1 as per inclusion process -> BIP... BIP-BIP	218	1	0: unlock 1: lock	0: unlock
Triac safe mode when an EP is transformed in to curtain the corresponding Triac is disabled (only for triac dev.)	221	1	0:unable 1:disable	N/A

Example of End Point Type values:

Button configured as EP_CENTRAL_SCENE. It sends through the Lifeline association group the "Central Scene Notification" commands. (CMD_Key_Pressed,CMD_Key_Released,CMD_Key_Held_Down). To set an EP_CENTRAL_SCENE use the Configuration command Class parameter 1->6, value 0x1A.

NODE CAPABILITIES

Basic, Generic and Specific Device Class

Informations below Reported from Node Information Frame (NIF)

NIF PARAMETER DESCRIPTOR	LIBRARY IDENTIFIER
Basic Device Class	BASIC_TYPE_ROUTING_SLAVE Routing Slave Enhanced 232
Generic Device Class	GENERIC_TYPE_SWITCH_BINARY
Specific Device Class	SPECIFIC_TYPE_POWER_SWITCH_BINARY

Command Classes

Informations below Reported from:

- Node Information Frame (NIF)
- Version CC, Version Get and Report commands

COMMAND CLASS	LIBRARY IDENTIFIER	VERSION
Z-Wave Plus Info	COMMAND_CLASS_ZWAVEPLUS_INFO	2
Version	COMMAND_CLASS_VERSION	2
Manufacturer Specific	COMMAND_CLASS_MANUFACTURER_SPECIFIC	2
Device Reset Locally	COMMAND_CLASS_DEVICE_RESET_LOCALLY	1
Powerlevel	COMMAND_CLASS_POWERLEVEL	1
Firmware Update Meta Data	COMMAND_CLASS_FIRMWARE_UPDATE_MD	4
Association	COMMAND_CLASS_ASSOCIATION	2
Multi Channel Association	COMMAND_CLASS_MULTI_CHANNEL_ASSOCIATION	3
AGI (Association Gorup Info)	COMMAND_CLASS_ASSOCIATION_GRP_INFO	1
Multi Channel	COMMAND_CLASS_MULTI_CHANNEL	4
Configuration	COMMAND_CLASS_CONFIGURATION	1
Manufacturer Proprietary	COMMAND_CLASS_MANUFACTURER_PROPRIETARY	1
Indicator	COMMAND_CLASS_INDICATOR	1
Node Name and Location	COMMAND_CLASS_NODE_NAMING	1
All Switch	COMMAND_CLASS_SWITCH_ALL	1

COMMAND CLASS MARK

Scene Activation	COMMAND_CLASS_SCENE_ACTIVATION	1
Central Scene	COMMAND_CLASS_CENTRAL_SCENE	1
Multilevel Switch	COMMAND_CLASS_SWITCH_MULTILEVEL	4
Binary Switch	COMMAND_CLASS_SWITCH_BINARY	1
Basic	COMMAND_CLASS_BASIC	1

Command Class Specification

COMMAND CLASS BASIC SET: MAX Value = [0x63 o 0xFF] -> [par31->36]
COMMAND CLASS INDICATOR values 0-7,0xFF

The version implemented is the #1 and may turn the device as a blinking indicator. The supported values are 0x00 (off/disable) or 0xFF (on/enable) and the field may carry valid values from 1 to 7.

0xFF: StartBlink(ALL_CHANNELS, YELLOW);
0x00: StopBlink(ALL_CHANNELS);

Valid values are:

1: white, 2: blue, 3: green, 4: cyan, 5: red, 6: magenta, 7: yellow

Timeout: ~60s

Generic and Specific Device Class by Curtain Endpoint

Informations below reported from Multi Channel Capability Report Command, valid if endpoint is set as "CURTAIN" only.

PARAMETER DESCRIPTOR	DESCRIPTION	LIBRARY IDENTIFIER
Generic Device Class	Switch Multilevel	GENERIC_TYPE_SWITCH_MULTILEVEL
Specific Device Class	Class A Motor Control	SPECIFIC_TYPE_CLASS_A_MOTOR_CONTROL

SUPPORTED COMMAND CLASS BY ENDPOINT

Informations below reported from Multi Channel Capability Report Command:

COMMAND CLASS	LIBRARY IDENTIFIER	VERSION
Binary	COMMAND_CLASS_SWITCH_BINARY	1
Multilevel Switch	COMMAND_CLASS_SWITCH_MULTILEVEL	4

DYNAMIC ENDPOINT EXPLANATION

Endpoints 1, 2, 3, set as "CURTAIN", are linked with endpoints 4, 5, 6 in vertical pairs, so endpoint 1 (direction up) is linked to endpoint 4 (direction down), and so on. Therefore endpoint 4, 5, 6, will not be "INTEROPERABLE" if a multichannel capability get is requested.

The valid endpoint association groups will be only 3, 4, 5. Relevant parameters are 191-196.

SPECIFICATIONS

Manufacturer ID: 0x010A

Models and Frequencies

REGION	CODE	FREQUENCY	PRODUCT TYPE ID	PRODUCT ID	APP ID
EU	01E06H041	868.4 Mhz	0x7115	0x1016	0x0215
IL	01EE60041	916 Mhz	0x7006	0x0F07	0x0106
KR	01EB6H040	921.4 Mhz	0x7116	0x1017	0x0216

Technical Specifications

Operating voltage	230 VAC 50 Hz
Consumption	<1.5W standby
Operating temperature	from 0°C to +40°C
Operating Humidity	20% - 90% RH non condensing
Storage temperature	from -40°C to +55°C
Storage Humidity	10% - 93% RH non condensing
IP Class	IP20
Package Dimension (W x H x D)	135 x 50 x 170 mm
Weight	~210 gr
RF radiated powered	2.5 mW (max)
RF range	Up to 40 m open range
Warranty	1 year

INSTALLATION

Wire the device according to the schematic below.

L Power connection (LIVE)
N Power connection (Neutral)

Position the device in the wall's mounting box and check cables are not interfering with the device case. Using the appropriate screw set that matches the wall box, fix the device in place without applying unnecessary torque to fixing screws.

Choosing a suitable location

Do not locate the device facing direct sunlight, humid or dusty place. The suitable ambient temperature is listed in specification.

Do not locate the device where there are any combustible substances or sources of heat (e.g. fires, radiators, boiler, etc.).

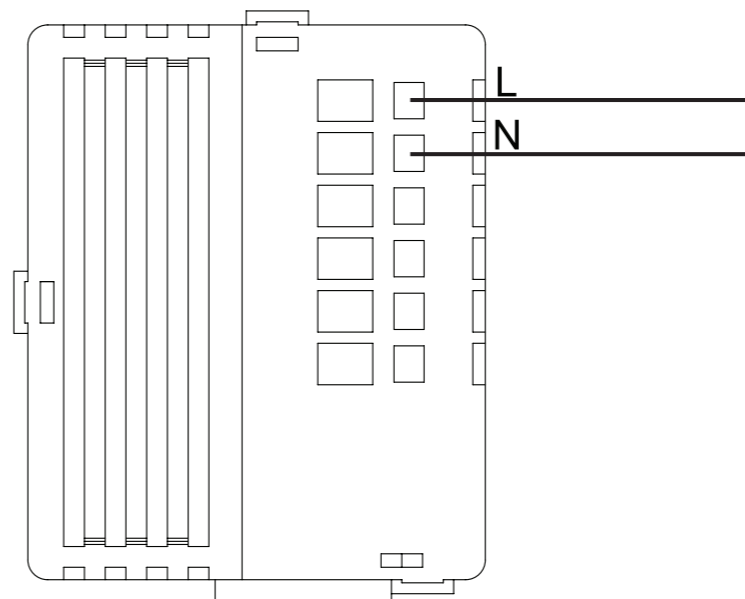

FUNCTIONS

Buttons and LEDs are numbered according the picture below facing front the device.

Each button has an RGB back-light LED that shows different colours during normal operation and certain sequence are also used to report special status.

Button #1 is used as **z-wave network button**

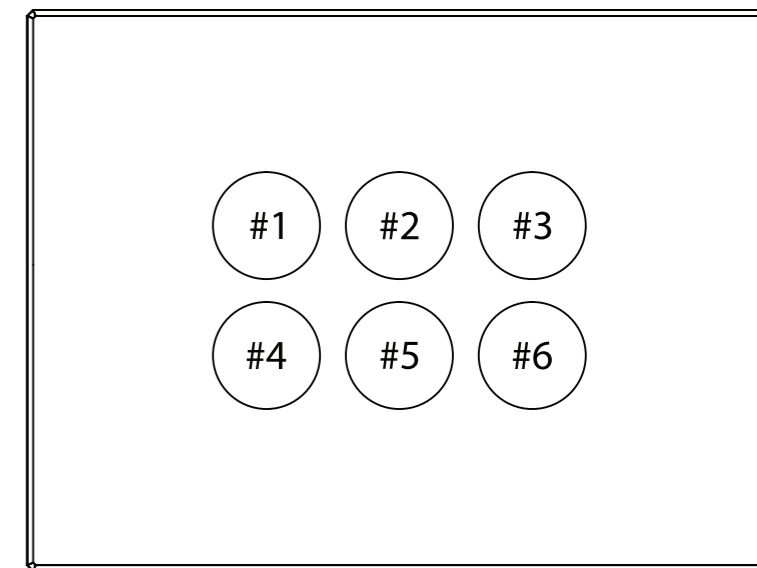

Special condition or status

LED	Colour codes	Description
LED #1	<i>blinks green for 5s</i>	<i>Valid HW signature detected at boot</i>
	<i>blinks red for 5s</i>	<i>Invalid HW signature detected at boot</i>
	<i>red glitch</i>	<i>When button #1 is touched indicates device is NOT included in the Z-Wave network</i>
	<i>Steady red</i>	<i>HW fault, contact assistance</i>

Normal operating condition or status

LED	Colour codes	Description
Any LED	<i>Steady blue</i>	<i>BASIC off or MULTILEVEL 0%</i>
	<i>Steady green</i>	<i>light dimming MULTILEVEL set at 33%</i>
	<i>Steady yellow</i>	<i>MULTILEVEL set at 100% or BASIC on</i>
	<i>Steady magenta</i>	<i>MOTOR control</i>

STANDARDS AND REGULATIONS

Electrical safety	(LVD) 2014/35/EU
Electromagnetic compatibility	(EMC) 2014/30/EU
Radio	(RED) 2014/53/EU
Presence of hazardous substances	(RoHS II) 2011/65/EU
Waste electrical and electronic equipment	(WEEE) 2012/19/EU

List of harmonized regulations applied

EN 301 489-1 V1.9.2; EN 301 489-3 V1.6.1
EN 50491-5-1:2010; EN 50491-5-2:2010
EN 60669-1:2000; EN 60669-1/A1:2003; EN60669-1/A2:2009
EN 60669-2-1:2004; EN 60669-2-1/A1:2009; EN 60669-2-1/A12:2009
EN 62479: 2010
EN 300 220-2 V.2.4.1





Model: WallZ-503
Type: 6CH-6TR
Code: 3M-01E06H062 4M-01Q06H062
Protocol: Z-Wave Plus

INTRODUCTION

Purpose of this document

This manual describes the most essential functions and technical specifications to help the electrician to install, setup and control the device. It is a Z-Wave Plus device of the Vitrum 2.0 product range. Visit our website for the complete list.

This document is also available on our web-site.

Notice

Dispose cardboard box & holder, plastic bags and front plastic shell according to local recycling regulation. Box and holder are PAP recyclable, plastic bags are LDPE, front shell is PP.

Safety

Take care of your safety. Use only insulated tools and remove power from the mains circuit breakers before and during any installation activity.

Caution

This device is a permanently connected to the mains thus implies it is mandatory to have a readily accessible disconnect device (like a circuit breaker) incorporated in the general wiring of the building with at least 3mm separation between contacts.

Danger: Risk of electrocution

Device installation and maintenance must be carried out by trained and skilled electricians in accordance with local wiring and building regulations. The device has no basic insulation and must never be used without the front glass plate. It must be installed in a way that protect from accidental contact. During installation procedure, the dummy plastic cover must be left on.

Before and during installation disconnect mains power.

Before you start

You will need available and ready to use:

- Small Phillips isolated screw driver
- Small slotted isolated driver (alternate)

Package content

- 1 x Wall mountable device
- 2 x Metric screw set
- 2 x Plastic screw set
- 1 x Protective shell

Preparation

Remove carefully the device from the cardboard support. Keep this manual for further reference.

Features

Touch operated button with RGB back-light.
 Based on Z-Wave [®] 500 module for wider coverage and higher data rate.
 Very low power consumption in standby.
 Easy installation.
 Acoustic feedback at button press.
 Over-the-air firmware update.

Z-WAVE NETWORKING

This product can be included and operates in any Z-Wave network with other Z-Wave certified devices from other manufacturers and/or other applications. This device is an always powered node and within the network will act as repeater regardless of vendor to increase reliability of the network.

ADD (inclusion)

The device supports both Normal Inclusion and Network Wide Inclusion.

Follow the steps below to include the device into the network:

1. Check the device is not already included in a Z-Wave network by pressing any button on the front panel: the LED button should blink with red colour shortly. Should the device be already included, follow the instructions below to excluded it from the network.
2. Set the controller into "Inclusion Mode". Refer to the controller documentation to set the controller into Inclusion mode.
3. Set the device into Learn Mode by pressing and holding button No.1 (on the top left of the device) for longer than 4 seconds. The device will enter into inclusion mode by blinking magenta LED button No.1. Upon successful completion, the device LEDs will blink green three times.
4. Should for any reasons the device fail the normal inclusion, the device turns to enter into the Network Wide Inclusion Mode up to 4 times. Any time the device enters into Wide Inclusion Mode, LED Button No.1 blinks Magenta.

REMOVE (exclusion)

Before starting to exclude the device from the network set the controller into "Exclusion Mode". Please refer to the controller documentation to set the controller into Exclusion mode.

The device can be excluded from a network only if previously included. Check that by pressing a button on the front panel: the LED button should not blink with red colour shortly.

Follow the steps below to exclude the device from the network:

1. Press and hold button No.1 (on the top left of the front panel device) for around 6 seconds and after that press 3 times the same button shortly within 3 seconds.
2. LED Button No.1 blinks red upon completely the device exclusion successfully.
3. Check the device is removed from the network by pressing button No.1: the LED button blinks red shortly.

Node Info Frame

To send a Node info frame press and release shortly the *HIDDEN BUTTON* (see picture on Installation paragraph) on the front end top-back of the device; a short audio signal (*beep*), will confirm the Node Info transmission.

If parameter 217 is set at 1 or 2 (see parameter table below), each button send a "Multichannel Capability Report". As default, parameter 217 is OFF.

Firmware Update

This device supports the firmware update which can be started from any certified Z-Wave controller supporting the Firmware Update Command Class version 3 and above. While updating the device works normally.

Just when the firmware update completes, the device will be inactive for few seconds during self-programming and rebooting.

During the reboot process, the local loads (if present) will be disengaged. Should the firmware update fail, the whole updating process must be re-started from the beginning.

The updating will last from 10 to 30 minutes depending on the network traffic condition.

Factory Default procedure

1. Start the factory default procedure by pressing and holding the hidden button on the front end top-back of the device till the buzzer plays a long beep (5 s).
2. Release the button and press it again till the buzzer plays a sequence of 3 short beeps.
3. The device will revert to its factory default settings, blinking all LED buttons and rebooting.

Do not disconnect the device from the power supply until reboot is completed.

Configuration and settings are restored to default values. "Home ID" and "Node ID" will be cleared as well.

ASSOCIATION/MULTICHANNEL ASSOCIATION

Association enables the device to control other nodes included in the same Z-Wave network for a maximum of **20 nodes** for **each button/group** with max **10 endpoints per Node**.

Group 1 Lifeline Notification

Max 20 associations available, Singlechannel or Multichannel.

Warning: In order to enable a controller to receive notifications with a endpoint source address from a Multichannel device, the controller must be associated to the lifeline group with the Multichannel association command class.

Example: if controller Node ID is 1, MULTICHANNEL ASSOCIATION must be set to the lifeline group 1 with controller nodeID(1) and endpoint(1)

Group 2 Reserved

Group 3 MAX_NODES_IN_GROUP 20

MAX_END_POINTS per Node: 10

Single channel association is only for root device so if used in a Multichannel environment the source and destination endpoint are lost. Multichannel Association instead contains the Source Endpoint and the Destination Endpoint so the device is addressed correctly.

General Rule for Groups

Each button has a dedicated group starting from #3 so button #1 is referred to **Group 3**, button #2 will control all the devices associated into group number 4 and so on. The number of groups depends on the number of endpoints (buttons). See table below for group association to buttons.

Messages sent by each group to associated devices are related to the "configuration type" of the endpoints.

Group N.	Button N.	Notes
1	-	Lifeline
2	-	Reserved
3	1	Always present
4	2	If present
5	3	If present
6	4	If present
7	5	If present
8	6	If present

PARAMETERS LIST

All parameters depends on their SIZE value. Size can be different from the table below. Before placing a "parameter #, SET value", always ask for a "Parameter #, GET" to retrieve the correct SIZE dimension.

See table below for the complete list of Configuration command Class parameters for all Vitrum products.

Description	Par. N. (Dec)	Size (B)	Value range	Default value
EP Type Button				
EP Type Button N.1 to N.6	1 to 6	1	0-26	Depends on specific device
End Point Type values				
EP_OFF			0	
EP_DIMMER			1 CC SWITCH MULTILEVEL - see par 31 to 36	
EP_SWITCHBUTTON			2 CC BASIC - see par 31 to 36	
EP_PUSHBUTTON			3 CC BASIC - see par 31 to 36	
EP_CURTAIN_1 Button			4 motor control with 1 button	
EP_CURTAIN			5 motor control with 2 buttons	
EP_MASTER_OFF			15 TBC	
EP_CURTAIN_UP			27 motor only up	
EP_CURTAIN_DOWN			28 motor only down	
Button Off Color				
Button N.1 to N.6 Off Color status	7 to 12	1	0-7	3
Button On Color				

Description	Par. N. (Dec)	Size (B)	Value range	Default value
Button N.1 to N.6 On Color status	13 to 18	1	0-7	4
Button Eco Color				
Button N.1 to N.6 Eco Color status	19 to 24	1	0-7	2
Button On/Off/Eco Color values list				
LED_COLOR_OFF	0			
LED_COLOR_RED	1			
LED_COLOR_GREEN	2			
LED_COLOR_BLU	3			
LED_COLOR_YELLOW	4			
LED_COLOR_MAGENTA	5			
LED_COLOR_CYAN	6			
LED_COLOR_WHITE	7			

Button to Output Port connection				
Output Port connected to Button N.1 to N.6	25 to 30	1	0-6	
Output Port				
Not connected to any port	0			
Output Port N.1 to N.6 connected to button	1 to 6			
Basic or Multilevel SET max value type	31 to 36	1	0 = 0x63 (100%) 1 = 0xFF (last level)	0: 0x63

Motors Control Time				
Channel 0 to 2 Motor Control Time (s)	191 to 193	1		60 (60 s)
Channel 0 Motor Control Switch All behavior (*1)	194	1		0
Channel 1 Motor Control Switch All behavior	195	1		0
Channel 2 Motor Control Switch All behavior	196	1		0
Lifeline queue time delay: <i>Add some delay to lifeline notifications</i>	215	2	1= 10 mS 10=100 mS 100=1000 mS	

NWI Enable	216	1	1: NWI enabled, default 0: learn mode classic only	
Multichannel Capability Report notification: Endpoint presentation after multichannel transmission	217	1	0: disabled, default 1: low power 2: Full Power	
Keyboard Lock Outputs and back-light still working 1. Lifeline notification CCConfig[218, 1] If a locked button is pressed 2. Force unlock: triple press on button 1 as per inclusion process -> BIP... BIP-BIP	218	1	0: unlock 1: lock	0: unlock
Triac safe mode when an EP is transformed in to curtain the corresponding Triac is disabled (only for triac dev.)	221	1	0:unable 1:disable	N/A

Example of End Point Type values:
Button configured as EP_CENTRAL_SCENE. It sends through the Lifeline association group the "Central Scene Notification" commands. (CMD_Key_Pressed, CMD_Key_Released, CMD_Key_Held_Down).
To set an EP_CENTRAL_SCENE use the Configuration command Class parameter 1->6, value 0x1A.

NODE CAPABILITIES

Basic, Generic and Specific Device Class

Informations below Reported from Node Information Frame (NIF)

NIF PARAMETER DESCRIPTOR	LIBRARY IDENTIFIER
Basic Device Class	BASIC_TYPE_ROUTING_SLAVE Routing Slave Enhanced 232
Generic Device Class	GENERIC_TYPE_SWITCH_BINARY
Specific Device Class	SPECIFIC_TYPE_POWER_SWITCH_BINARY

Command Classes

Informations below Reported from:

- Node Information Frame (NIF)
- Version CC, Version Get and Report commands

COMMAND CLASS	LIBRARY IDENTIFIER	VERSION
Z-Wave Plus Info	COMMAND_CLASS_ZWAVEPLUS_INFO	2
Version	COMMAND_CLASS_VERSION	2
Manufacturer Specific	COMMAND_CLASS_MANUFACTURER_SPECIFIC	2
Device Reset Locally	COMMAND_CLASS_DEVICE_RESET_LOCALLY	1
Powerlevel	COMMAND_CLASS_POWERLEVEL	1
Firmware Update Meta Data	COMMAND_CLASS_FIRMWARE_UPDATE_MD	4
Association	COMMAND_CLASS_ASSOCIATION	2
Multi Channel Association	COMMAND_CLASS_MULTI_CHANNEL_ASSOCIATION	3
AGI (Association Gorup Info)	COMMAND_CLASS_ASSOCIATION_GRP_INFO	1
Multi Channel	COMMAND_CLASS_MULTI_CHANNEL	4
Configuration	COMMAND_CLASS_CONFIGURATION	1
Manufacturer Proprietary	COMMAND_CLASS_MANUFACTURER_PROPRIETARY	1
Indicator	COMMAND_CLASS_INDICATOR	1
Node Name and Location	COMMAND_CLASS_NODE_NAMING	1
All Switch	COMMAND_CLASS_SWITCH_ALL	1
COMMAND CLASS MARK		
Scene Activation	COMMAND_CLASS_SCENE_ACTIVATION	1
Central Scene	COMMAND_CLASS_CENTRAL_SCENE	1
Multilevel Switch	COMMAND_CLASS_SWITCH_MULTILEVEL	4
Binary Switch	COMMAND_CLASS_SWITCH_BINARY	1
Basic	COMMAND_CLASS_BASIC	1

Command Class Specification

COMMAND CLASS BASIC SET: MAX Value = [0x63 o 0xFF] -> [par31->36]
COMMAND CLASS INDICATOR values 0-7, 0xFF

The version implemented is the #1 and may turn the device as a blinking indicator. The supported values are 0x00 (off/disable) or 0xFF (on/enable) and the field may carry valid values from 1 to 7.

0xFF: StartBlink(ALL_CHANNELS, YELLOW);
0x00: StopBlink(ALL_CHANNELS);

Valid values are:

1: white, 2: blue, 3: green, 4: cyan, 5: red, 6: magenta, 7: yellow

Timeout: ~60s

Generic and Specific Device Class by Curtain Endpoint

Informations below reported from Multi Channel Capability Report Command, valid if endpoint is set as "CURTAIN" only.

PARAMETER DESCRIPTOR	DESCRIPTION	LIBRARY IDENTIFIER
Generic Device Class	Switch Multilevel	GENERIC_TYPE_SWITCH_MULTILEVEL
Specific Device Class	Class A Motor Control	SPECIFIC_TYPE_CLASS_A_MOTOR_CONTROL

SUPPORTED COMMAND CLASS BY ENDPOINT

Informations below reported from Multi Channel Capability Report Command:

COMMAND CLASS	LIBRARY IDENTIFIER	VERSION
Binary	COMMAND_CLASS_SWITCH_BINARY	1
Multilevel Switch	COMMAND_CLASS_SWITCH_MULTILEVEL	4

DYNAMIC ENDPOINT EXPLANATION

Endpoints 1, 2, 3, set as "CURTAIN", are linked with endpoints 4, 5, 6 in vertical pairs, so endpoint 1 (direction up) is linked to endpoint 4 (direction down), and so on. Therefore endpoint 4, 5, 6, will not be "INTEROPERABLE" if a multichannel capability get is requested.

The valid endpoint association groups will be only 3, 4, 5. Relevant parameters are 191-196.

SPECIFICATIONS

Manufacturer ID: 0x010A

Models and Frequencies

REGION	CODE	FREQUENCY	PRODUCT TYPE ID	PRODUCT ID	APP ID
EU	01E06H062	868.4 Mhz	0x7115	0x1016	0x0215
IL	01EE60060	916 Mhz	0x7006	0x0F07	0x0106
KR	01EB6H060	921.4 Mhz	0x7116	0x1017	0x0216

Technical Specifications

Operating voltage	230 VAC 50 Hz
Consumption	<1.5W standby
Operating temperature	from 0°C to +40°C
Operating Humidity	20% - 90% RH non condensing
Storage temperature	from -40°C to +55°C
Storage Humidity	10% - 93% RH non condensing
IP Class	IP20
Package Dimension (W x H x D)	135 x 50 x 170 mm
Weight	~210 gr
RF radiated powered	2.5 mW (max)
RF range	Up to 40 m open range
Warranty	1 year

INSTALLATION

Wire the device according to the schematic below.

- L Power connection (LIVE)
- N Power connection (Neutral)

Position the device in the wall's mounting box and check cables are not interfering with the device case. Using the appropriate screw set that matches the wall box, fix the device in place without applying unnecessary torque to fixing screws.

Choosing a suitable location

Do not locate the device facing direct sunlight, humid or dusty place. The suitable ambient temperature is listed in specification.

Do not locate the device where there are any combustible substances or sources of heat (e.g. fires, radiators, boiler, etc.).

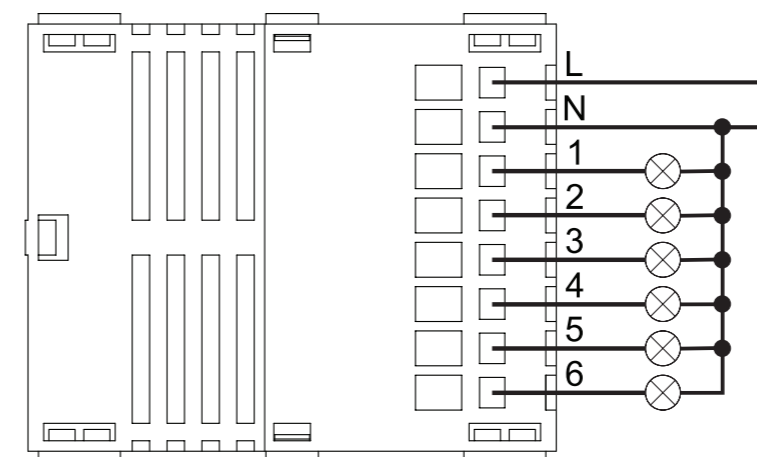

⚠ ATTENTION: need a protection relay, only when is used for motor

FUNCTIONS

Buttons and LEDs are numbered according the picture below facing front the device.

Each button has an RGB back-light LED that shows different colours during normal operation and certain sequence are also used to report special status.

Button #1 is used as **z-wave network button**

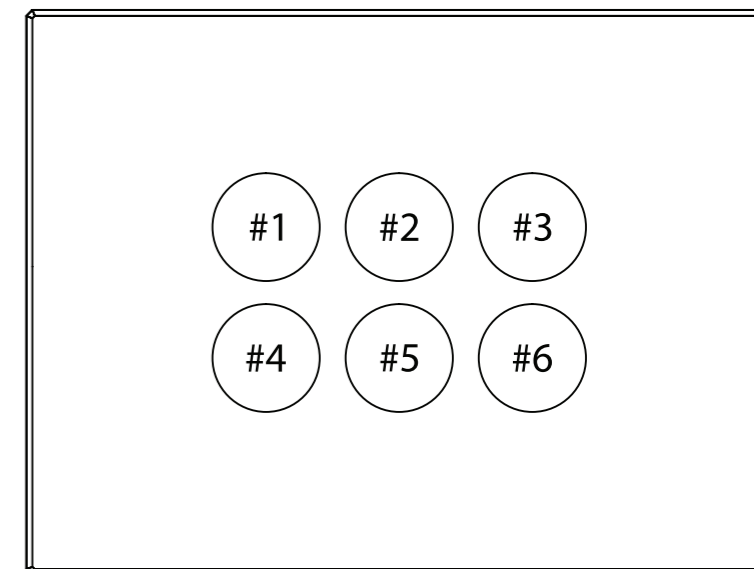

Special condition or status

LED	Colour codes	Description
LED #1	<i>blinks green for 5s</i>	<i>Valid HW signature detected at boot</i>
	<i>blinks red for 5s</i>	<i>Invalid HW signature detected at boot</i>
	<i>red glitch</i>	<i>When button #1 is touched indicates device is NOT included in the Z-Wave network</i>
	<i>Steady red</i>	<i>HW fault, contact assistance</i>

Normal operating condition or status

LED	Colour codes	Description
Any LED	<i>Steady blue</i>	<i>BASIC off or MULTILEVEL 0%</i>
	<i>Steady green</i>	<i>light dimming MULTILEVEL set at 33%</i>
	<i>Steady yellow</i>	<i>MULTILEVEL set at 100% or BASIC on</i>
	<i>Steady magenta</i>	<i>MOTOR control</i>

STANDARDS AND REGULATIONS

Electrical safety	(LVD) 2014/35/EU
Electromagnetic compatibility	(EMC) 2014/30/EU
Radio	(RED) 2014/53/EU
Presence of hazardous substances	(RoHS II) 2011/65/EU
Waste electrical and electronic equipment	(WEEE) 2012/19/EU

List of harmonized regulations applied

EN 301 489-1 V1.9.2; EN 301 489-3 V1.6.1
EN 50491-5-1:2010; EN 50491-5-2:2010
EN 60669-1:2000; EN 60669-1/A1:2003; EN60669-1/A2:2009
EN 60669-2-1:2004; EN 60669-2-1/A1:2009; EN 60669-2-1/A12:2009
EN 62479: 2010
EN 300 220-2 V.2.4.1



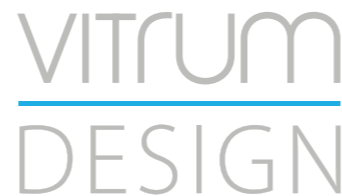

Model: WallZ-503
Type: Therm-1CH
Code: 3M-02E00H020 4M-02Q00H020
Protocol: Z-Wave Plus

INTRODUCTION

Purpose of this document

This manual describes the most essential functions and technical specifications to help the electrician to install, setup and control the device. It is a Z-Wave Plus device of the Vitrum 2.0 product range. Visit our website for the complete list.

This document is also available on our web-site.

Notice

Dispose cardboard box & holder, plastic bags and front plastic shell according to local recycling regulation. Box and holder are PAP recyclable, plastic bags are LDPE, front shell is PP.

Safety

Take care of your safety. Use only insulated tools and remove power from the mains circuit breakers before and during any installation activity.

Caution

This device is a permanently connected to the mains thus implies it is mandatory to have a readily accessible disconnect device (like a circuit breaker) incorporated in the general wiring of the building with at least 3mm separation between contacts.

Danger: Risk of electrocution

Device installation and maintenance must be carried out by trained and skilled electricians in accordance with local wiring and building regulations. The device has no basic insulation and must never be used without the front glass plate. It must be installed in a way that protect from accidental contact. During installation procedure, the dummy plastic cover must be left on.

Before and during installation disconnect mains power.

Before you start

You will need available and ready to use:

- Small Phillips isolated screw driver
- Small slotted isolated driver (alternate)

Package content

- 1 x Wall mountable device
- 2 x Metric screw set
- 2 x Plastic screw set
- 1 x Protective shell

Preparation

Remove carefully the device from the cardboard support. Keep this manual for further reference.

Features

Touch operated button with RGB back-light.
 Based on Z-Wave[®] 500 module for wider coverage and higher data rate.
 Very low power consumption in standby.
 Easy installation.
 Acoustic feedback at button press.
 Over-the-air firmware update.

Z-WAVE NETWORKING

This product can be included and operates in any Z-Wave network with other Z-Wave certified devices from other manufacturers and/or other applications. This device is an always powered node and within the network will act as repeater regardless of vendor to increase reliability of the network.

ADD (inclusion)

The device supports both Normal Inclusion and Network Wide Inclusion.

Follow the steps below to include the device into the network:

1. Check the device is not already included in a Z-Wave network by pressing any button on the front panel: the LED button should blink with red colour shortly. Should the device be already included, follow the instructions below to excluded it from the network.
2. Set the controller into "Inclusion Mode". Refer to the controller documentation to set the controller into Inclusion mode.
3. Set the device into Learn Mode by pressing and holding button No.1 (on the top left of the device) for longer than 4 seconds. The device will enter into inclusion mode by blinking magenta LED button No.1. Upon successful completion, the device LEDs will blink green three times.
4. Should for any reasons the device fail the normal inclusion, the device turns to enter into the Network Wide Inclusion Mode up to 4 times. Any time the device enters into Wide Inclusion Mode, LED Button No.1 blinks Magenta.

REMOVE (exclusion)

Before starting to exclude the device from the network set the controller into "Exclusion Mode". Please refer to the controller documentation to set the controller into Exclusion mode.

The device can be excluded from a network only if previously included. Check that by pressing a button on the front panel: the LED button should not blink with red colour shortly.

Follow the steps below to exclude the device from the network:

1. Press and hold button No.1 (on the top left of the front panel device) for around 6 seconds and after that press 3 times the same button shortly within 3 seconds.
2. LED Button No.1 blinks red upon completely the device exclusion successfully.
3. Check the device is removed from the network by pressing button No.1: the LED button blinks red shortly.

Firmware Update

This device supports the firmware update which can be started from any certified Z-Wave controller supporting the Firmware Update Command Class version 3 and above. While updating the device works normally.

Just when the firmware update completes, the device will be inactive for few seconds during self-programming and rebooting.

During the reboot process, the local loads (if present) will be disengaged. Should the firmware update fail, the whole updating process must be re-started from the beginning.

The updating will last from 10 to 30 minutes depending on the network traffic condition.

ASSOCIATION/MULTICHANNEL ASSOCIATION

Association enables the device to control other nodes included in the same Z-Wave network for a maximum of **20 nodes** for **each button/group** with max **10 endpoints per Node**.

Group 1 Lifeline Notification

Max 20 associations available, Singlechannel or Multichannel.

Warning: In order to enable a controller to receive notifications with a endpoint source address from a Multichannel device, the controller must be associated to the lifeline group with the Multichannel association command class.

Example: if controller Node ID is 1, MULTICHANNEL ASSOCIATION must be set to the lifeline group 1 with controller nodeID(1) and endpoint(1)

Group 2 Reserved

Group 3 MAX_NODES_IN_GROUP 20

MAX_END_POINTS per Node: 10

Single channel association is only for root device so if used in a Multichannel environment the source and destination endpoint are lost. Multichannel Association instead contains the Source Endpoint and the Destination Endpoint so the device is addressed correctly.

General Rule for Groups

Each button has a dedicated group starting from #3 so button #1 is referred to **Group 3**, button #2 will control all the devices associated into group number 4 and so on. The number of groups depends on the number of endpoints (buttons). See table below for group association to buttons.

Messages sent by each group to associated devices are related to the "configuration type" of the endpoints.

Group N.	Button N.	Notes
1	-	Lifeline
2	-	Reserved
3	1	Always present
4	2	If present
5	3	If present
6	4	If present
7	5	If present
8	6	If present

PARAMETERS LIST

GROUP NAME	MAX NODES	DESCRIPRION
Lifeline	20	Send 'Thermostat Mode Report' command every time the Thermostat mode status has changed; Send Thermostat 'Set Point Report' command every time the Set Point value has changed; Send 'Fan Mode Report' command every time Fan Mode status has changed; Send 'Basic Report' command every time a Basic Set from Heating Valve and Cooling Valve groups has been sent; Send 'Binary Switch Report' command every time: <ul style="list-style-type: none"> • the local relay on board has been switched on/ • of • the Set Point Mode button has been pressed • the remote heating or cooling valve has been 'Binary Switch Set' Send 'Device Reset Locally Notification' to report Factory Reset event.
Sensor multi-level get	20	Send 'Sensor Multilevel Get' to report temperature from a sensor device
Fan mode	20	Send 'Fan Mode Set' command every time Fan Mode button is pressed
Thermostat mode	20	Send 'Thermostat Mode Set' command every time the Thermostat mode has changed
Set point	20	Send 'Thermostat Set Point Set' command every time the Set Point has changed

Set point	20	Send 'Binary Switch Set' ON/OFF command to an heating valve
Cooling Valve	20	Send 'Binary Switch Set' ON/OFF command to an cooling valve
Switch Multi-level	20	Send 'Switch Multilevel Set' command according to Fans Coil speed to reach
Binary Switch	20	Send 'Binary Switch Set' ON every time button N.2 is pressed

CONFIGURATION

Parameter name	Default value	Size	Value range
Output port Heating	0	1	0: Disconnected 1: Output driven by heating algorithm
Output port Cooling	0	1	2: Output driven by cooling algorithm Remark: connecting to an output port already connected, will force the previously connected one to be automatically disconnected
Setpoint Step	50	1	1, 10, 20, 50, 100 cents of degree
Max Setpoint Value	3500	2	0-65535 cents of degree
Min Setpoint Value	1000	2	0-65535 cents of degree
Thermostat Operating Mode	0	1	0: Hotel Mode 1: Home Mode 2: Display Only Mode
Temperature Unit Display Mode	0	1	0: Celsius 1: Fahrenheit 2: Clock
Temperature Button Display Mode	0	1	0: Set Point and Temperature 1: Temperature and Setpoint 2: Clock and Temperature
Display status	0	1	0: AUTO, FAN1, FAN2, FAN3 1-15: Other settings
Fan Coil Button Display Mode	0	1	0: OFF 1: hyphens 2: Temperature
Temperature Unit Display Mode	0	1	0: Always Celsius 1: Always Fahrenheit 2: According to user setting (see OPERATING) or par. N.118 setting
Switch display on remote setting	0	1	0: Display stays of 1: Turns on display upon receiving a remote setting
Min Temperature Deviation	5	1	1-254 Min temperature deviation to be reported on lifeline
Thermostat of state Forced Ventilation	0	1	0: Disabled 1: Enabled
FAN Speed Change delay	2	1	0-10 s delay to switch fan speed
PID Gain	25	1	0-255
PID Integral Time	15	1	0-255 minutes
PID Dead Band	10	1	0-255 Tens of degree
PID 4-Pipe Heating System Band	16	1	0-255 Tens of degree
PID Fan Coil Speed 2 Threshold	3333	2	From 1 to "PID Fan Coil Speed 3 Threshold"
PID Fan Coil Speed 3 Threshold	6666	2	From "PID Fan Coil Speed 2 Threshold" to 10000

Fan Coil Speed Hysteresis	650	2	From 0 to "PID Fan Coil Speed 2 Threshold" (Default 650 is 6,5% of 10K)
PID 0-10V Fan Coil Min Voltage Output	0	1	From 0 to "0-10V Fan Coil Max Voltage Output"
PID 0-10V Fan Coil Max Voltage Output	100	1	From "0-10V Fan Coil Min Voltage" to 100
Heating System Hysteresis Band	4	1	0-255 Cents of degree
Sampling Time	10	1	1-255 s
Buttons Max. Brightness	100	1	From "Buttons Min. Brightness" to 100
Buttons Min. Brightness	5	1	From 0 to "Buttons Max. Brightness"
Buzzer	1	1	0: disabled 1: enabled
Front-end Buttons lock	0	1	0: disabled 1: enabled

Command Classes

Informations below Reported from:

- Node Information Frame (NIF)
- Version CC, Version Get and Report commands

COMMAND CLASS	LIBRARY IDENTIFIER	VERSION
Z-Wave Plus Info	COMMAND_CLASS_ZWAVEPLUS_INFO	2
Version	COMMAND_CLASS_VERSION	2
Manufacturer Specific	COMMAND_CLASS_MANUFACTURER_SPECIFIC	2
Device Reset Locally	COMMAND_CLASS_DEVICE_RESET_LOCALLY	1
Powerlevel	COMMAND_CLASS_POWERLEVEL	1
Firmware Update Meta Data	COMMAND_CLASS_FIRMWARE_UPDATE_MD	4
Association	COMMAND_CLASS_ASSOCIATION	2
Multi Channel Association	COMMAND_CLASS_MULTI_CHANNEL_ASSOCIATION	3
AGI (Association Gorup Info)	COMMAND_CLASS_ASSOCIATION_GRP_INFO	1
Multi Channel	COMMAND_CLASS_MULTI_CHANNEL	4
Configuration	COMMAND_CLASS_CONFIGURATION	1
Manufacturer Proprietary	COMMAND_CLASS_MANUFACTURER_PROPRIETARY	1
Indicator	COMMAND_CLASS_INDICATOR	1
Node Name and Location	COMMAND_CLASS_NODE_NAMING	1
All Switch	COMMAND_CLASS_SWITCH_ALL	1

COMMAND CLASS MARK

Scene Activation	COMMAND_CLASS_SCENE_ACTIVATION	1
Central Scene	COMMAND_CLASS_CENTRAL_SCENE	1
Multilevel Switch	COMMAND_CLASS_SWITCH_MULTILEVEL	4
Binary Switch	COMMAND_CLASS_SWITCH_BINARY	1
Basic	COMMAND_CLASS_BASIC	1

Command Class Specification

COMMAND CLASS BASIC SET: MAX Value = [0x63 o 0xFF] -> [par31->36]
COMMAND CLASS INDICATOR values 0-7,0xff

The version implemented is the #1 and may turn the device as a blinking indicator. The supported values are 0x00 (off/disable) or 0xFF (on/enable) and the field may carry valid values from 1 to 7.

0xFF: StartBlink(ALL_CHANNELS, YELLOW);
0x00: StopBlink(ALL_CHANNELS);

Valid values are:

1: white, 2: blue, 3: green, 4: cyan, 5: red, 6: magenta, 7: yellow

Timeout: ~60s

The valid endpoint association groups will be only 3, 4, 5. Relevant parameters are 191-196.

Generic and Specific Device Class by Curtain Endpoint

Informations below reported from Multi Channel Capability Report Command, valid if endpoint is set as "CURTAIN" only.

PARAMETER DESCRIPTOR	DESCRIPTION	LIBRARY IDENTIFIER
Generic Device Class	Switch Multilevel	GENERIC_TYPE_SWITCH_MULTILEVEL
Specific Device Class	Class A Motor Control	SPECIFIC_TYPE_CLASS_A_MOTOR_CONTROL

SUPPORTED COMMAND CLASS BY ENDPOINT

Informations below reported from Multi Channel Capability Report Command:

COMMAND CLASS	LIBRARY IDENTIFIER	VERSION
Binary	COMMAND_CLASS_SWITCH_BINARY	1
Multilevel Switch	COMMAND_CLASS_SWITCH_MULTILEVEL	4

DYNAMIC ENDPOINT EXPLANATION

Endpoints 1, 2, 3, set as "CURTAIN", are linked with endpoints 4, 5, 6 in vertical pairs, so endpoint 1 (direction up) is linked to endpoint 4 (direction down), and so on. Therefore endpoint 4, 5, 6, will not be "INTEROPERABLE" if a multichannel capability get is requested.

The valid endpoint association groups will be only 3, 4, 5. Relevant parameters are 191-196.

SPECIFICATIONS

Manufacturer ID: 0x010A

Models and Frequencies

REGION	CODE	FREQUENCY	PRODUCT TYPE ID	PRODUCT ID	APP ID
EU	02E00H020	868.4 Mhz	0x7115	0x1016	0x0215
IL	02EE00020	916 Mhz	0x7006	0x0F07	0x0106
KR	02EB0H020	921.4 Mhz	0x7116	0x1017	0x0216

Technical Specifications

Operating voltage	230 VAC 50 Hz
Consumption	<1.5W standby
Operating temperature	from 0°C to +40°C
Operating Humidity	20% - 90% RH non condensing
Storage temperature	from -40°C to +55°C
Storage Humidity	10% - 93% RH non condensing
IP Class	IP20
Package Dimension (W x H x D)	
Weight	~210 gr
RF radiated powered	2.5 mW (max)
RF range	Up to 40 m open range
Warranty	1 year

INSTALLATION

Wire the device according to the schematic below.

L Power connection (LIVE)
N Power connection (Neutral)

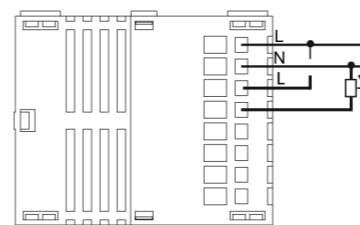

For reset the electronics contact Vitrum Design assistance

FUNCTIONS

Buttons and LEDs are numbered according the picture below facing front the device.

Each button has an RGB back-light LED that shows different colours during normal operation and certain sequence are also used to report special status.

Button #1 is used as **z-wave network button**

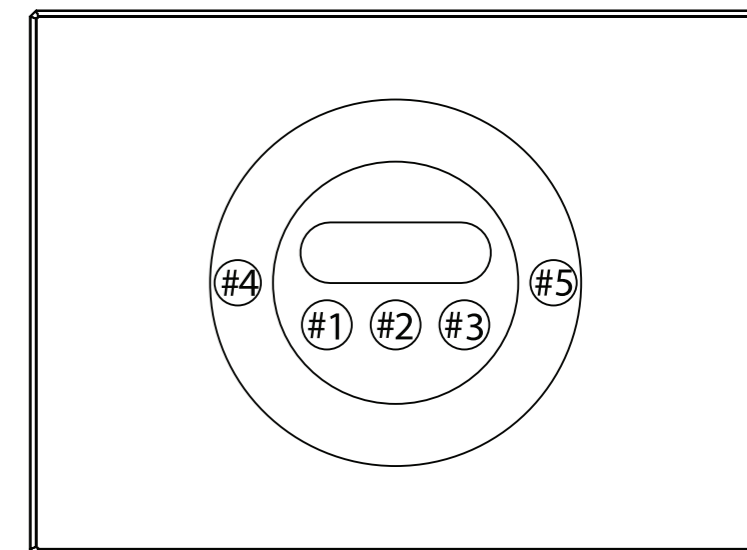

Special condition or status

LED	Colour codes	Description
LED #1	<i>blinks green for 5s</i>	<i>Valid HW signature detected at boot</i>
	<i>blinks red for 5s</i>	<i>Invalid HW signature detected at boot</i>
	<i>red glitch</i>	<i>When button #1 is touched indicates device is NOT included in the Z-Wave network</i>
	<i>Steady red</i>	<i>HW fault, contact assistance</i>

Normal operating condition or status

LED	Colour codes	Description
Any LED	<i>Steady blue</i>	<i>BASIC off or MULTILEVEL 0%</i>
	<i>Steady green</i>	<i>light dimming MULTILEVEL set at 33%</i>
	<i>Steady yellow</i>	<i>MULTILEVEL set at 100% or BASIC on</i>
	<i>Steady magenta</i>	<i>MOTOR control</i>

STANDARDS AND REGULATIONS

Electrical safety	(LVD) 2014/35/EU
Electromagnetic compatibility	(EMC) 2014/30/EU
Radio	(RED) 2014/53/EU
Presence of hazardous substances	(RoHS II) 2011/65/EU
Waste electrical and electronic equipment	(WEEE) 2012/19/EU

List of harmonized regulations applied

EN 301 489-1 V1.9.2; EN 301 489-3 V1.6.1
EN 50491-5-1:2010; EN 50491-5-2:2010
EN 60669-1:2000; EN 60669-1/A1:2003; EN60669-1/A2:2009
EN 60669-2-1:2004; EN 60669-2-1/A1:2009; EN 60669-2-1/A12:2009
EN 62479: 2010
EN 300 220-2 V.2.4.1





Model: WallZ-BS
Type: 1CH-1RL
Code: 01B01H020
Protocol: Z-Wave Plus

INTRODUCTION

Purpose of this document

This manual describes the most essential functions and technical specifications to help the electrician to install, setup and control the device. It is a Z-Wave Plus device of the Vitrum 2.0 product range. Visit our website for the complete list.

This document is also available on our web-site.

Notice

Dispose cardboard box & holder, plastic bags and front plastic shell according to local recycling regulation. Box and holder are PAP recyclable, plastic bags are LDPE, front shell is PP.

Safety

Take care of your safety. Use only insulated tools and remove power from the mains circuit breakers before and during any installation activity.

Caution

This device is a permanently connected to the mains thus implies it is mandatory to have a readily accessible disconnect device (like a circuit breaker) incorporated in the general wiring of the building with at least 3mm separation between contacts.

Danger: Risk of electrocution

Device installation and maintenance must be carried out by trained and skilled electricians in accordance with local wiring and building regulations. The device has no basic insulation and must never be used without the front glass plate. It must be installed in a way that protect from accidental contact. During installation procedure, the dummy plastic cover must be left on.

Before and during installation disconnect mains power.

Before you start

You will need available and ready to use:

- Small Phillips isolated screw driver
- Small slotted isolated driver (alternate)

Package content

- 1 x Wall mountable device
- 2 x Metric screw set
- 2 x Plastic screw set
- 1 x Protective shell

Preparation

Remove carefully the device from the cardboard support. Keep this manual for further reference.

Features

Touch operated button with RGB back-light.
 Based on Z-Wave[®] 500 module for wider coverage and higher data rate.
 Very low power consumption in standby.
 Easy installation.
 Acoustic feedback at button press.
 Over-the-air firmware update.

Z-WAVE NETWORKING

This product can be included and operates in any Z-Wave network with other Z-Wave certified devices from other manufacturers and/or other applications. This device is an always powered node and within the network will act as repeater regardless of vendor to increase reliability of the network.

ADD (inclusion)

The device supports both Normal Inclusion and Network Wide Inclusion.

Follow the steps below to include the device into the network:

1. Check the device is not already included in a Z-Wave network by pressing any button on the front panel: the LED button should blink with red colour shortly. Should the device be already included, follow the instructions below to excluded it from the network.
2. Set the controller into "Inclusion Mode". Refer to the controller documentation to set the controller into Inclusion mode.
3. Set the device into Learn Mode by pressing and holding button No.1 (on the top left of the device) for longer than 4 seconds. The device will enter into inclusion mode by blinking magenta LED button No.1. Upon successful completion, the device LEDs will blink green three times.
4. Should for any reasons the device fail the normal inclusion, the device turns to enter into the Network Wide Inclusion Mode up to 4 times. Any time the device enters into Wide Inclusion Mode, LED Button No.1 blinks Magenta.

REMOVE (exclusion)

Before starting to exclude the device from the network set the controller into "Exclusion Mode". Please refer to the controller documentation to set the controller into Exclusion mode.

The device can be excluded from a network only if previously included. Check that by pressing a button on the front panel: the LED button should not blink with red colour shortly.

Follow the steps below to exclude the device from the network:

1. Press and hold button No.1 (on the top left of the front panel device) for around 6 seconds and after that press 3 times the same button shortly within 3 seconds.
2. LED Button No.1 blinks red upon completely the device exclusion successfully.
3. Check the device is removed from the network by pressing button No.1: the LED button blinks red shortly.

Node Info Frame

To send a Node info frame press and release shortly the *HIDDEN BUTTON* (see picture on Installation paragraph) on the front end top-back of the device; a short audio signal (*beep*), will confirm the Node Info transmission.

If parameter 217 is set at 1 or 2 (see parameter table below), each button send a "Multichannel Capability Report". As default, parameter 217 is OFF.

Firmware Update

This device supports the firmware update which can be started from any certified Z-Wave controller supporting the Firmware Update Command Class version 3 and above. While updating the device works normally.

Just when the firmware update completes, the device will be inactive for few seconds during self-programming and rebooting.

During the reboot process, the local loads (if present) will be disengaged. Should the firmware update fail, the whole updating process must be re-started from the beginning.

The updating will last from 10 to 30 minutes depending on the network traffic condition.

Factory Default procedure

1. Start the factory default procedure by pressing and holding the hidden button on the front end top-back of the device till the buzzer plays a long beep (5 s).
2. Release the button and press it again till the buzzer plays a sequence of 3 short beeps.
3. The device will revert to its factory default settings, blinking all LED buttons and rebooting.

Do not disconnect the device from the power supply until reboot is completed.

Configuration and settings are restored to default values. "Home ID" and "Node ID" will be cleared as well.

ASSOCIATION/MULTICHANNEL ASSOCIATION

Association enables the device to control other nodes included in the same Z-Wave network for a maximum of **20 nodes** for **each button/group** with max **10 endpoints per Node**.

Group 1 Lifeline Notification

Max 20 associations available, Singlechannel or Multichannel.

Warning: In order to enable a controller to receive notifications with a endpoint source address from a Multichannel device, the controller must be associated to the lifeline group with the Multichannel association command class.

Example: if controller Node ID is 1, MULTICHANNEL ASSOCIATION must be set to the lifeline group 1 with controller nodeID(1) and endpoint(1)

Group 2 Reserved

Group 3 MAX_NODES_IN_GROUP 20

MAX_END_POINTS per Node: 10

Single channel association is only for root device so if used in a Multichannel environment the source and destination endpoint are lost. Multichannel Association instead contains the Source Endpoint and the Destination Endpoint so the device is addressed correctly.

General Rule for Groups

Each button has a dedicated group starting from #3 so button #1 is referred to **Group 3**, button #2 will control all the devices associated into group number 4 and so on. The number of groups depends on the number of endpoints (buttons). See table below for group association to buttons.

Messages sent by each group to associated devices are related to the "configuration type" of the endpoints.

Group N.	Button N.	Notes
1	-	Lifeline
2	-	Reserved
3	1	Always present
4	2	If present
5	3	If present
6	4	If present
7	5	If present
8	6	If present

PARAMETERS LIST

All parameters depends on their SIZE value. Size can be different from the table below. Before placing a "parameter #, SET value", always ask for a "Parameter #, GET" to retrieve the correct SIZE dimension.

See table below for the complete list of Configuration command Class parameters for all Vitrum products.

Description	Par. N. (Dec)	Size (B)	Value range	Default value
EP Type Button				
EP Type Button N.1 to N.6	1 to 6	1	0-26	Depends on specific device
End Point Type values				
EP_OFF	0			
EP_DIMMER	1		CC SWITCH MULTILEVEL - see par 31 to 36	
EP_SWITCHBUTTON	2		CC BASIC - see par 31 to 36	
EP_PUSHBUTTON	3		CC BASIC - see par 31 to 36	
EP_CURTAIN_1 Button	4		motor control with 1 button	
EP_CURTAIN	5		motor control with 2 buttons	
EP_MASTER_OFF	15		TBC	
EP_CURTAIN_UP	27		motor only up	
EP_CURTAIN_DOWN	28		motor only down	
Button Off Color				
Button N.1 to N.6 Off Color status	7 to 12	1	0-7	3
Button On Color				

Description	Par. N. (Dec)	Size (B)	Value range	Default value
Button N.1 to N.6 On Color status	13 to 18	1	0-7	4
Button Eco Color				
Button N.1 to N.6 Eco Color status	19 to 24	1	0-7	2
Button On/Off/Eco Color values list				
LED_COLOR_OFF	0			
LED_COLOR_RED	1			
LED_COLOR_GREEN	2			
LED_COLOR_BLU	3			
LED_COLOR_YELLOW	4			
LED_COLOR_MAGENTA	5			
LED_COLOR_CYAN	6			
LED_COLOR_WHITE	7			

Button to Output Port connection

Output Port connected to Button N.1 to N.6	25 to 30	1	0-6	
Output Port				
Not connected to any port	0			
Output Port N.1 to N.6 connected to button	1 to 6			
Basic or Multilevel SET max value type	31 to 36	1	0 = 0x63 (100%) 1 = 0xFF (last level)	0: 0x63

Motors Control Time

Channel 0 to 2 Motor Control Time (s)	191 to 193	1		60 (60 s)
Channel 0 Motor Control Switch All behavior (*1)	194	1		0
Channel 1 Motor Control Switch All behavior	195	1		0
Channel 2 Motor Control Switch All behavior	196	1		0
Lifeline queue time delay: <i>Add some delay to lifeline notifications</i>	215	2	1= 10 mS 10=100 mS 100=1000 mS	
NWI Enable	216	1	1: NWI enabled, default 0: learn mode classic only	
Multichannel Capability Report notification: Endpoint presentation after multichannel transmission	217	1	0: disabled, default 1: low power 2: Full Power	
Keyboard Lock Outputs and back-light still working 1. Lifeline notification CCConfig[218, 1] If a locked button is pressed 2. Force unlock: triple press on button 1 as per inclusion process -> BIP... BIP-BIP	218	1	0: unlock 1: lock	0: unlock
Triac safe mode when an EP is transformed in to curtain the corresponding Triac is disabled (only for triac dev.)	221	1	0:unable 1:disable	N/A

Example of End Point Type values:

Button configured as EP_CENTRAL_SCENE. It sends through the Lifeline association group the "Central Scene Notification" commands. (CMD_Key_Pressed,CMD_Key_Released,CMD_Key_Held_Down). To set an EP_CENTRAL_SCENE use the Configuration command Class parameter 1->6, value 0x1A.

NODE CAPABILITIES

Basic, Generic and Specific Device Class

Informations below Reported from Node Information Frame (NIF)

NIF PARAMETER DESCRIPTOR	LIBRARY IDENTIFIER
Basic Device Class	BASIC_TYPE_ROUTING_SLAVE Routing Slave Enhanced 232
Generic Device Class	GENERIC_TYPE_SWITCH_BINARY
Specific Device Class	SPECIFIC_TYPE_POWER_SWITCH_BINARY

Command Classes

Informations below Reported from:

- Node Information Frame (NIF)
- Version CC, Version Get and Report commands

COMMAND CLASS	LIBRARY IDENTIFIER	VERSION
Z-Wave Plus Info	COMMAND_CLASS_ZWAVEPLUS_INFO	2
Version	COMMAND_CLASS_VERSION	2
Manufacturer Specific	COMMAND_CLASS_MANUFACTURER_SPECIFIC	2
Device Reset Locally	COMMAND_CLASS_DEVICE_RESET_LOCALLY	1
Powerlevel	COMMAND_CLASS_POWERLEVEL	1
Firmware Update Meta Data	COMMAND_CLASS_FIRMWARE_UPDATE_MD	4
Association	COMMAND_CLASS_ASSOCIATION	2
Multi Channel Association	COMMAND_CLASS_MULTI_CHANNEL_ASSOCIATION	3
AGI (Association Gorup Info)	COMMAND_CLASS_ASSOCIATION_GRP_INFO	1
Multi Channel	COMMAND_CLASS_MULTI_CHANNEL	4
Configuration	COMMAND_CLASS_CONFIGURATION	1
Manufacturer Proprietary	COMMAND_CLASS_MANUFACTURER_PROPRIETARY	1
Indicator	COMMAND_CLASS_INDICATOR	1
Node Name and Location	COMMAND_CLASS_NODE_NAMING	1
All Switch	COMMAND_CLASS_SWITCH_ALL	1

COMMAND CLASS MARK

Scene Activation	COMMAND_CLASS_SCENE_ACTIVATION	1
Central Scene	COMMAND_CLASS_CENTRAL_SCENE	1
Multilevel Switch	COMMAND_CLASS_SWITCH_MULTILEVEL	4
Binary Switch	COMMAND_CLASS_SWITCH_BINARY	1
Basic	COMMAND_CLASS_BASIC	1

Command Class Specification

COMMAND CLASS BASIC SET: MAX Value = [0x63 o 0xFF] -> [par31->36]
COMMAND CLASS INDICATOR values 0-7,0xFF

The version implemented is the #1 and may turn the device as a blinking indicator. The supported values are 0x00 (off/disable) or 0xFF (on/enable) and the field may carry valid values from 1 to 7.

0xFF: StartBlink(ALL_CHANNELS, YELLOW);
0x00: StopBlink(ALL_CHANNELS);

Valid values are:

1: white, 2: blue, 3: green, 4: cyan, 5: red, 6: magenta, 7: yellow

Timeout: ~60s

Generic and Specific Device Class by Curtain Endpoint

Informations below reported from Multi Channel Capability Report Command, valid if endpoint is set as "CURTAIN" only.

PARAMETER DESCRIPTOR	DESCRIPTION	LIBRARY IDENTIFIER
Generic Device Class	Switch Multilevel	GENERIC_TYPE_SWITCH_MULTILEVEL
Specific Device Class	Class A Motor Control	SPECIFIC_TYPE_CLASS_A_MOTOR_CONTROL

SUPPORTED COMMAND CLASS BY ENDPOINT

Informations below reported from Multi Channel Capability Report Command:

COMMAND CLASS	LIBRARY IDENTIFIER	VERSION
Binary	COMMAND_CLASS_SWITCH_BINARY	1
Multilevel Switch	COMMAND_CLASS_SWITCH_MULTILEVEL	4

DYNAMIC ENDPOINT EXPLANATION

Endpoints 1, 2, 3, set as "CURTAIN", are linked with endpoints 4, 5, 6 in vertical pairs, so endpoint 1 (direction up) is linked to endpoint 4 (direction down), and so on. Therefore endpoint 4, 5, 6, will not be "INTEROPERABLE" if a multichannel capability get is requested.

The valid endpoint association groups will be only 3, 4, 5. Relevant parameters are 191-196.

SPECIFICATIONS

Manufacturer ID: 0x010A

Models and Frequencies

REGION	CODE	FREQUENCY	PRODUCT TYPE ID	PRODUCT ID	APP ID
EU		868.4 Mhz	0x7115	0x1016	0x0215
IL		916 Mhz	0x7006	0x0F07	0x0106
KR		921.4 Mhz	0x7116	0x1017	0x0216

Technical Specifications

Operating voltage	230 VAC 50 Hz
Consumption	<1.5W standby
Operating temperature	from 0°C to +40°C
Operating Humidity	20% - 90% RH non condensing
Storage temperature	from -40°C to +55°C
Storage Humidity	10% - 93% RH non condensing
IP Class	IP20
Package Dimension (W x H x D)	135 x 50 x 170 mm
Weight	~210 gr
RF radiated powered	2.5 mW (max)
RF range	Up to 40 m open range
Warranty	1 year

INSTALLATION

Wire the device according to the schematic below.

- L Power connection (LIVE)
- N Power connection (Neutral)

Position the device in the wall's mounting box and check cables are not interfering with the device case. Using the appropriate screw set that matches the wall box, fix the device in place without applying unnecessary torque to fixing screws.

Choosing a suitable location

Do not locate the device facing direct sunlight, humid or dusty place. The suitable ambient temperature is listed in specification.

Do not locate the device where there are any combustible substances or sources of heat (e.g. fires, radiators, boiler, etc.).

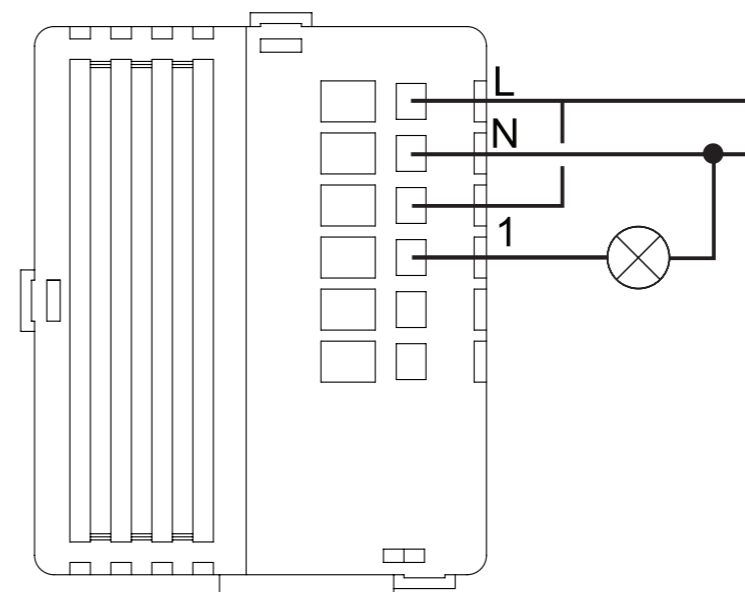

FUNCTIONS

Buttons and LEDs are numbered according the picture below facing front the device.

Each button has an RGB back-light LED that shows different colours during normal operation and certain sequence are also used to report special status.

Button #1 is used as **z-wave network button**

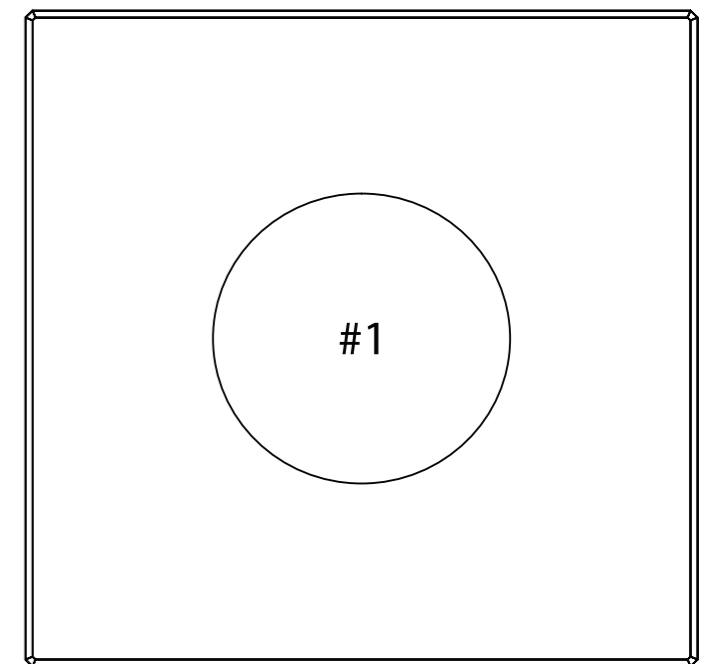

Special condition or status

LED	Colour codes	Description
LED #1	<i>blinks green for 5s</i>	<i>Valid HW signature detected at boot</i>
	<i>blinks red for 5s</i>	<i>Invalid HW signature detected at boot</i>
	<i>red glitch</i>	<i>When button #1 is touched indicates device is NOT included in the Z-Wave network</i>
	<i>Steady red</i>	<i>HW fault, contact assistance</i>

Normal operating condition or status

LED	Colour codes	Description
Any LED	<i>Steady blue</i>	<i>BASIC off or MULTILEVEL 0%</i>
	<i>Steady green</i>	<i>light dimming MULTILEVEL set at 33%</i>
	<i>Steady yellow</i>	<i>MULTILEVEL set at 100% or BASIC on</i>
	<i>Steady magenta</i>	<i>MOTOR control</i>

STANDARDS AND REGULATIONS

Electrical safety	(LVD) 2014/35/EU
Electromagnetic compatibility	(EMC) 2014/30/EU
Radio	(RED) 2014/53/EU
Presence of hazardous substances	(RoHS II) 2011/65/EU
Waste electrical and electronic equipment	(WEEE) 2012/19/EU

List of harmonized regulations applied

EN 301 489-1 V1.9.2; EN 301 489-3 V1.6.1
EN 50491-5-1:2010; EN 50491-5-2:2010
EN 60669-1:2000; EN 60669-1/A1:2003; EN60669-1/A2:2009
EN 60669-2-1:2004; EN 60669-2-1/A1:2009; EN 60669-2-1/A12:2009
EN 62479: 2010
EN 300 220-2 V.2.4.1



Model: WallZ-BS
Type: 2CH-1M
Code: 01B02H011
Protocol: Z-Wave Plus

INTRODUCTION

Purpose of this document

This manual describes the most essential functions and technical specifications to help the electrician to install, setup and control the device. It is a Z-Wave Plus device of the Vitrum 2.0 product range. Visit our website for the complete list.

This document is also available on our web-site.

Notice

Dispose cardboard box & holder, plastic bags and front plastic shell according to local recycling regulation. Box and holder are PAP recyclable, plastic bags are LDPE, front shell is PP.

Safety

Take care of your safety. Use only insulated tools and remove power from the mains circuit breakers before and during any installation activity.

Caution

This device is a permanently connected to the mains thus implies it is mandatory to have a readily accessible disconnect device (like a circuit breaker) incorporated in the general wiring of the building with at least 3mm separation between contacts.

Danger: Risk of electrocution

Device installation and maintenance must be carried out by trained and skilled electricians in accordance with local wiring and building regulations. The device has no basic insulation and must never be used without the front glass plate. It must be installed in a way that protect from accidental contact. During installation procedure, the dummy plastic cover must be left on.

Before and during installation disconnect mains power.

Before you start

You will need available and ready to use:

- Small Phillips isolated screw driver
- Small slotted isolated driver (alternate)

Package content

- 1 x Wall mountable device
- 2 x Metric screw set
- 2 x Plastic screw set
- 1 x Protective shell

Preparation

Remove carefully the device from the cardboard support. Keep this manual for further reference.

Features

Touch operated button with RGB back-light.
 Based on Z-Wave[®] 500 module for wider coverage and higher data rate.
 Very low power consumption in standby.
 Easy installation.
 Acoustic feedback at button press.
 Over-the-air firmware update.

Z-WAVE NETWORKING

This product can be included and operates in any Z-Wave network with other Z-Wave certified devices from other manufacturers and/or other applications. This device is an always powered node and within the network will act as repeater regardless of vendor to increase reliability of the network.

ADD (inclusion)

The device supports both Normal Inclusion and Network Wide Inclusion.

Follow the steps below to include the device into the network:

1. Check the device is not already included in a Z-Wave network by pressing any button on the front panel: the LED button should blink with red colour shortly. Should the device be already included, follow the instructions below to excluded it from the network.
2. Set the controller into "Inclusion Mode". Refer to the controller documentation to set the controller into Inclusion mode.
3. Set the device into Learn Mode by pressing and holding button No.1 (on the top left of the device) for longer than 4 seconds. The device will enter into inclusion mode by blinking magenta LED button No.1. Upon successful completion, the device LEDs will blink green three times.
4. Should for any reasons the device fail the normal inclusion, the device turns to enter into the Network Wide Inclusion Mode up to 4 times. Any time the device enters into Wide Inclusion Mode, LED Button No.1 blinks Magenta.

REMOVE (exclusion)

Before starting to exclude the device from the network set the controller into "Exclusion Mode". Please refer to the controller documentation to set the controller into Exclusion mode.

The device can be excluded from a network only if previously included. Check that by pressing a button on the front panel: the LED button should not blink with red colour shortly.

Follow the steps below to exclude the device from the network:

1. Press and hold button No.1 (on the top left of the front panel device) for around 6 seconds and after that press 3 times the same button shortly within 3 seconds.
2. LED Button No.1 blinks red upon completely the device exclusion successfully.
3. Check the device is removed from the network by pressing button No.1: the LED button blinks red shortly.

Node Info Frame

To send a Node info frame press and release shortly the *HIDDEN BUTTON* (see picture on Installation paragraph) on the front end top-back of the device; a short audio signal (*beep*), will confirm the Node Info transmission.

If parameter 217 is set at 1 or 2 (see parameter table below), each button send a "Multichannel Capability Report". As default, parameter 217 is OFF.

Firmware Update

This device supports the firmware update which can be started from any certified Z-Wave controller supporting the Firmware Update Command Class version 3 and above. While updating the device works normally.

Just when the firmware update completes, the device will be inactive for few seconds during self-programming and rebooting.

During the reboot process, the local loads (if present) will be disengaged. Should the firmware update fail, the whole updating process must be re-started from the beginning.

The updating will last from 10 to 30 minutes depending on the network traffic condition.

Factory Default procedure

1. Start the factory default procedure by pressing and holding the hidden button on the front end top-back of the device till the buzzer plays a long beep (5 s).
2. Release the button and press it again till the buzzer plays a sequence of 3 short beeps.
3. The device will revert to its factory default settings, blinking all LED buttons and rebooting.

Do not disconnect the device from the power supply until reboot is completed.

Configuration and settings are restored to default values. "Home ID" and "Node ID" will be cleared as well.

ASSOCIATION/MULTICHANNEL ASSOCIATION

Association enables the device to control other nodes included in the same Z-Wave network for a maximum of **20 nodes** for **each button/group** with max **10 endpoints per Node**.

Group 1 Lifeline Notification

EP_OFF	0
EP_CURTAIN	5 MOTOR CONTROL WITH 2 BUTTONS

Group 2 Reserved

Group 3 MAX_NODES_IN_GROUP 20

MAX_END_POINTS per Node: 10

Single channel association is only for root device so if used in a Multichannel environment the source and destination endpoint are lost. Multichannel Association instead contains the Source Endpoint and the Destination Endpoint so the device is addressed correctly.

General Rule for Groups

Each button has a dedicated group starting from #3 so button #1 is referred to **Group 3**, button #2 will control all the devices associated into group number 4 and so on. The number of groups depends on the number of endpoints (buttons). See table below for group association to buttons.

Messages sent by each group to associated devices are related to the "configuration type" of the endpoints.

Group N.	Button N.	Notes
1	-	Lifeline
2	-	Reserved
3	1	Always present
4	2	If present
5	3	If present
6	4	If present
7	5	If present
8	6	If present

PARAMETERS LIST

All parameters depends on their SIZE value. Size can be different from the table below. Before placing a "parameter #, SET value", always ask for a "Parameter #, GET" to retrieve the correct SIZE dimension.

See table below for the complete list of Configuration command Class parameters for all Vitrum products.

Description	Par. N. (Dec)	Size (B)	Value range	Default value
EP Type Button				
EP Type Button N.1 to N.6	1 to 6	1	0-26	Depends on specific device
End Point Type values				
EP_OFF	0			
EP_DIMMER	1		CC SWITCH MULTILEVEL - see par 31 to 36	
EP_SWITCHBUTTON	2		CC BASIC - see par 31 to 36	
EP_PUSHBUTTON	3		CC BASIC - see par 31 to 36	
EP CURTAIN_1 Button	4		motor control with 1 button	
EP_CURTAIN	5		motor control with 2 buttons	
EP_MASTER_OFF	15		TBC	
EP CURTAIN_UP	27		motor only up	
EP CURTAIN_DOWN	28		motor only down	
Button Off Color				
Button N.1 to N.6 Off Color status	7 to 12	1	0-7	3
Button On Color				

Description	Par. N. (Dec)	Size (B)	Value range	Default value
Button N.1 to N.6 On Color status	13 to 18	1	0-7	4
Button Eco Color				
Button N.1 to N.6 Eco Color status	19 to 24	1	0-7	2
Button On/Off/Eco Color values list				
LED_COLOR_OFF	0			
LED_COLOR_RED	1			
LED_COLOR_GREEN	2			
LED_COLOR_BLU	3			
LED_COLOR_YELLOW	4			
LED_COLOR_MAGENTA	5			
LED_COLOR_CYAN	6			
LED_COLOR_WHITE	7			

Button to Output Port connection				
Output Port connected to Button N.1 to N.6	25 to 30	1	0-6	
Output Port				
Not connected to any port	0			
Output Port N.1 to N.6 connected to button	1 to 6			
Basic or Multilevel SET max value type	31 to 36	1	0 = 0x63 (100%) 1 = 0xFF (last level)	0: 0x63

Motors Control Time				
Channel 0 to 2 Motor Control Time (s)	191 to 193	1		60 (60 s)
Channel 0 Motor Control Switch All behavior (*1)	194	1		0
Channel 1 Motor Control Switch All behavior	195	1		0
Channel 2 Motor Control Switch All behavior	196	1		0
Lifeline queue time delay: <i>Add some delay to lifeline notifications</i>	215	2	1= 10 mS 10=100 mS 100=1000 mS	
NWI Enable	216	1	1: NWI enabled, default 0: learn mode classic only	

Multichannel Capability Report notification: Endpoint presentation after multichannel transmission	217	1	0: disabled, default 1: low power 2: Full Power	
Keyboard Lock Outputs and back-light still working 1. Lifeline notification CCConfig[218, 1] If a locked button is pressed 2. Force unlock: triple press on button 1 as per inclusion process -> BIP... BIP-BIP	218	1	0: unlock 1: lock	0: unlock
Triac safe mode when an EP is transformed in to curtain the corresponding Triac is disabled (only for triac dev.)	221	1	0:unable 1:disable	N/A

Example of **End Point Type values**:
Button configured as EP_CENTRAL_SCENE. It sends through the Lifeline association group the "Central Scene Notification" commands. (CMD_Key_Pressed,CMD_Key_Released,CMD_Key_Held_Down).
To set an EP_CENTRAL_SCENE use the Configuration command Class parameter 1->6, value 0x1A.

NODE CAPABILITIES

Basic, Generic and Specific Device Class

Informations below Reported from Node Information Frame (NIF)

NIF PARAMETER DESCRIPTOR	LIBRARY IDENTIFIER
Basic Device Class	BASIC_TYPE_ROUTING_SLAVE Routing Slave Enhanced 232
Generic Device Class	GENERIC_TYPE_SWITCH_BINARY
Specific Device Class	SPECIFIC_TYPE_POWER_SWITCH_BINARY

Command Classes

Informations below Reported from:

- Node Information Frame (NIF)
- Version CC, Version Get and Report commands

COMMAND CLASS	LIBRARY IDENTIFIER	VERSION
Z-Wave Plus Info	COMMAND_CLASS_ZWAVEPLUS_INFO	2
Version	COMMAND_CLASS_VERSION	2
Manufacturer Specific	COMMAND_CLASS_MANUFACTURER_SPECIFIC	2
Device Reset Locally	COMMAND_CLASS_DEVICE_RESET_LOCALLY	1
Powerlevel	COMMAND_CLASS_POWERLEVEL	1
Firmware Update Meta Data	COMMAND_CLASS_FIRMWARE_UPDATE_MD	4
Association	COMMAND_CLASS_ASSOCIATION	2
Multi Channel Association	COMMAND_CLASS_MULTI_CHANNEL_ASSOCIATION	3
AGI (Association Gorup Info)	COMMAND_CLASS_ASSOCIATION_GRP_INFO	1
Multi Channel	COMMAND_CLASS_MULTI_CHANNEL	4
Configuration	COMMAND_CLASS_CONFIGURATION	1
Manufacturer Proprietary	COMMAND_CLASS_MANUFACTURER_PROPRIETARY	1
Indicator	COMMAND_CLASS_INDICATOR	1
Node Name and Location	COMMAND_CLASS_NODE_NAMING	1
All Switch	COMMAND_CLASS_SWITCH_ALL	1

COMMAND CLASS MARK		
Scene Activation	COMMAND_CLASS_SCENE_ACTIVATION	1
Central Scene	COMMAND_CLASS_CENTRAL_SCENE	1
Multilevel Switch	COMMAND_CLASS_SWITCH_MULTILEVEL	4
Binary Switch	COMMAND_CLASS_SWITCH_BINARY	1
Basic	COMMAND_CLASS_BASIC	1

Command Class Specification

COMMAND CLASS BASIC SET: MAX Value = [0x63 o 0xFF] -> [par31->36]
COMMAND CLASS INDICATOR values 0-7,0xFF

The version implemented is the #1 and may turn the device as a blinking indicator. The supported values are 0x00 (off/disable) or 0xFF (on/enable) and the field may carry valid values from 1 to 7.

0xFF: StartBlink(ALL_CHANNELS, YELLOW);
0x00: StopBlink(ALL_CHANNELS);

Valid values are:

1: white, 2: blue, 3: green, 4: cyan, 5: red, 6: magenta, 7: yellow

Timeout: ~60s

Generic and Specific Device Class by Curtain Endpoint

Informations below reported from Multi Channel Capability Report Command, valid if endpoint is set as "CURTAIN" only.

PARAMETER DESCRIPTOR	DESCRIPTION	LIBRARY IDENTIFIER
Generic Device Class	Switch Multilevel	GENERIC_TYPE_SWITCH_MULTILEVEL
Specific Device Class	Class A Motor Control	SPECIFIC_TYPE_CLASS_A_MOTOR_CONTROL

SUPPORTED COMMAND CLASS BY ENDPOINT

Informations below reported from Multi Channel Capability Report Command:

COMMAND CLASS	LIBRARY IDENTIFIER	VERSION
Binary	COMMAND_CLASS_SWITCH_BINARY	1
Multilevel Switch	COMMAND_CLASS_SWITCH_MULTILEVEL	4

DYNAMIC ENDPOINT EXPLANATION

Endpoints 1, 2, 3, set as "CURTAIN", are linked with endpoints 4, 5, 6 in vertical pairs, so endpoint 1 (direction up) is linked to endpoint 4 (direction down), and so on. Therefore endpoint 4, 5, 6, will not be "INTEROPERABLE" if a multichannel capability get is requested.

The valid endpoint association groups will be only 3, 4, 5. Relevant parameters are 191-196.

SPECIFICATIONS

Manufacturer ID: 0x010A

Models and Frequencies

REGION	CODE	FREQUENCY	PRODUCT TYPE ID	PRODUCT ID	APP ID
EU	02B02H011	868.4 Mhz	0x7115	0x1016	0x0215
IL	02BE20020	916 Mhz	0x7006	0x0F07	0x0106
KR	02BB2H020	921.4 Mhz	0x7116	0x1017	0x0216

Technical Specifications

Operating voltage	230 VAC 50 Hz
Consumption	<1.5W standby
Operating temperature	from 0°C to +40°C
Operating Humidity	20% - 90% RH non condensing
Storage temperature	from -40°C to +55°C
Storage Humidity	10% - 93% RH non condensing
IP Class	IP20
Package Dimension (W x H x D)	135 x 50 x 170 mm
Weight	~210 gr
RF radiated powered	2.5 mW (max)
RF range	Up to 40 m open range
Warranty	1 year

INSTALLATION

Wire the device according to the schematic below.

L Power connection (LIVE)
N Power connection (Neutral)

Position the device in the wall's mounting box and check cables are not interfering with the device case. Using the appropriate screw set that matches the wall box, fix the device in place without applying unnecessary torque to fixing screws.

Choosing a suitable location

Do not locate the device facing direct sunlight, humid or dusty place. The suitable ambient temperature is listed in specification.

Do not locate the device where there are any combustible substances or sources of heat (e.g. fires, radiators, boiler, etc.).

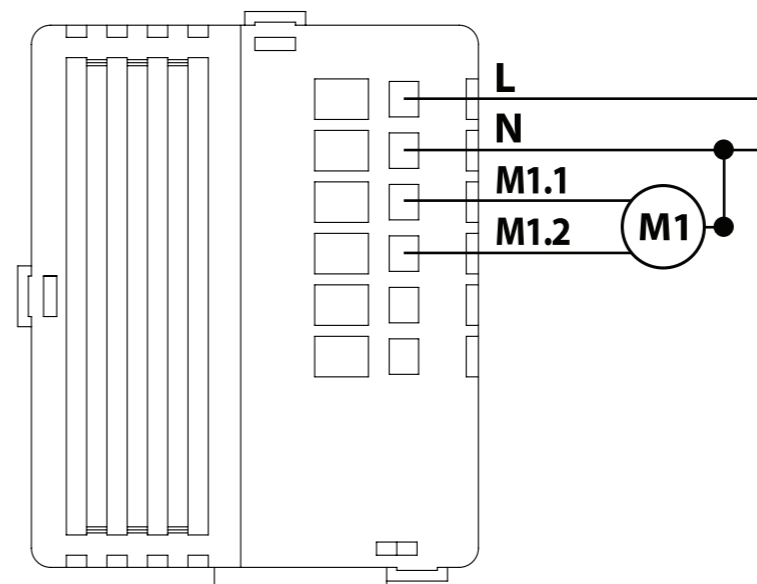

FUNCTIONS

Buttons and LEDs are numbered according the picture below facing front the device.

Each button has an RGB back-light LED that shows different colours during normal operation and certain sequence are also used to report special status.

Button #1 is used as **z-wave network button**

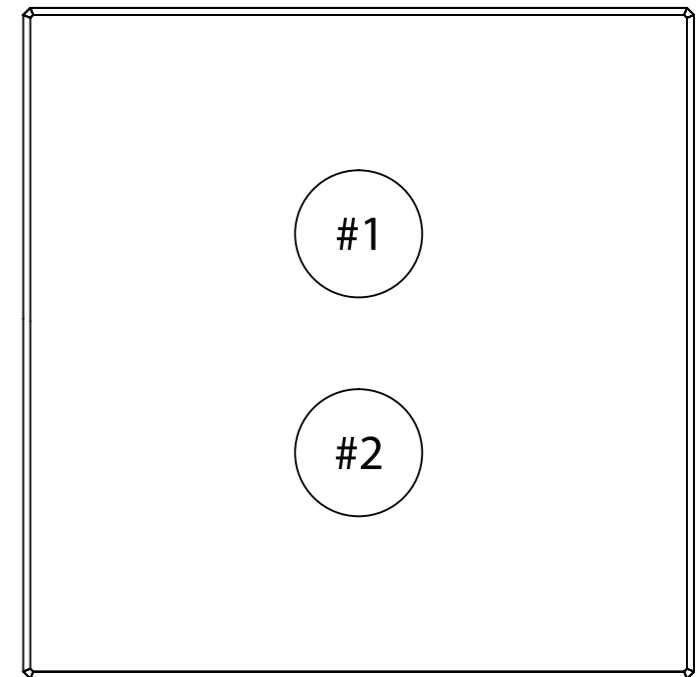

Special condition or status

LED	Colour codes	Description
LED #1	<i>blinks green for 5s</i>	<i>Valid HW signature detected at boot</i>
	<i>blinks red for 5s</i>	<i>Invalid HW signature detected at boot</i>
	<i>red glitch</i>	<i>When button #1 is touched indicates device is NOT included in the Z-Wave network</i>
	<i>Steady red</i>	<i>HW fault, contact assistance</i>

Normal operating condition or status

LED	Colour codes	Description
Any LED	<i>Steady blue</i>	<i>BASIC off or MULTILEVEL 0%</i>
	<i>Steady green</i>	<i>light dimming MULTILEVEL set at 33%</i>
	<i>Steady yellow</i>	<i>MULTILEVEL set at 100% or BASIC on</i>
	<i>Steady magenta</i>	<i>MOTOR control</i>

STANDARDS AND REGULATIONS

Electrical safety	(LVD) 2014/35/EU
Electromagnetic compatibility	(EMC) 2014/30/EU
Radio	(RED) 2014/53/EU
Presence of hazardous substances	(RoHS II) 2011/65/EU
Waste electrical and electronic equipment	(WEEE) 2012/19/EU

List of harmonized regulations applied

EN 301 489-1 V1.9.2; EN 301 489-3 V1.6.1
EN 50491-5-1:2010; EN 50491-5-2:2010
EN 60669-1:2000; EN 60669-1/A1:2003; EN60669-1/A2:2009
EN 60669-2-1:2004; EN 60669-2-1/A1:2009; EN 60669-2-1/A12:2009
EN 62479: 2010
EN 300 220-2 V.2.4.1



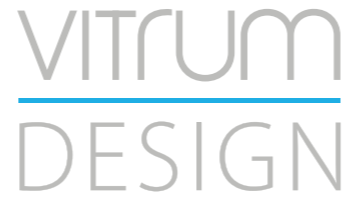

Model: WallZ-BS
Type: 2CH-2RL
Code: 01B02H020
Protocol: Z-Wave Plus

INTRODUCTION

Purpose of this document

This manual describes the most essential functions and technical specifications to help the electrician to install, setup and control the device. It is a Z-Wave Plus device of the Vitrum 2.0 product range. Visit our website for the complete list.

This document is also available on our web-site.

Notice

Dispose cardboard box & holder, plastic bags and front plastic shell according to local recycling regulation. Box and holder are PAP recyclable, plastic bags are LDPE, front shell is PP.

Safety

Take care of your safety. Use only insulated tools and remove power from the mains circuit breakers before and during any installation activity.

Caution

This device is a permanently connected to the mains thus implies it is mandatory to have a readily accessible disconnect device (like a circuit breaker) incorporated in the general wiring of the building with at least 3mm separation between contacts.

Danger: Risk of electrocution

Device installation and maintenance must be carried out by trained and skilled electricians in accordance with local wiring and building regulations. The device has no basic insulation and must never be used without the front glass plate. It must be installed in a way that protect from accidental contact. During installation procedure, the dummy plastic cover must be left on.

Before and during installation disconnect mains power.

Before you start

You will need available and ready to use:

- Small Phillips isolated screw driver
- Small slotted isolated driver (alternate)

Package content

- 1 x Wall mountable device
- 2 x Metric screw set
- 2 x Plastic screw set
- 1 x Protective shell

Preparation

Remove carefully the device from the cardboard support. Keep this manual for further reference.

Features

Touch operated button with RGB back-light.
 Based on Z-Wave[®] 500 module for wider coverage and higher data rate.
 Very low power consumption in standby.
 Easy installation.
 Acoustic feedback at button press.
 Over-the-air firmware update.

Z-WAVE NETWORKING

This product can be included and operates in any Z-Wave network with other Z-Wave certified devices from other manufacturers and/or other applications. This device is an always powered node and within the network will act as repeater regardless of vendor to increase reliability of the network.

ADD (inclusion)

The device supports both Normal Inclusion and Network Wide Inclusion.

Follow the steps below to include the device into the network:

1. Check the device is not already included in a Z-Wave network by pressing any button on the front panel: the LED button should blink with red colour shortly. Should the device be already included, follow the instructions below to excluded it from the network.
2. Set the controller into "Inclusion Mode". Refer to the controller documentation to set the controller into Inclusion mode.
3. Set the device into Learn Mode by pressing and holding button No.1 (on the top left of the device) for longer than 4 seconds. The device will enter into inclusion mode by blinking magenta LED button No.1. Upon successful completion, the device LEDs will blink green three times.
4. Should for any reasons the device fail the normal inclusion, the device turns to enter into the Network Wide Inclusion Mode up to 4 times. Any time the device enters into Wide Inclusion Mode, LED Button No.1 blinks Magenta.

REMOVE (exclusion)

Before starting to exclude the device from the network set the controller into "Exclusion Mode". Please refer to the controller documentation to set the controller into Exclusion mode.

The device can be excluded from a network only if previously included. Check that by pressing a button on the front panel: the LED button should not blink with red colour shortly.

Follow the steps below to exclude the device from the network:

1. Press and hold button No.1 (on the top left of the front panel device) for around 6 seconds and after that press 3 times the same button shortly within 3 seconds.
2. LED Button No.1 blinks red upon completely the device exclusion successfully.
3. Check the device is removed from the network by pressing button No.1: the LED button blinks red shortly.

Node Info Frame

To send a Node info frame press and release shortly the *HIDDEN BUTTON* (see picture on Installation paragraph) on the front end top-back of the device; a short audio signal (*beep*), will confirm the Node Info transmission.

If parameter 217 is set at 1 or 2 (see parameter table below), each button send a "Multichannel Capability Report". As default, parameter 217 is OFF.

Firmware Update

This device supports the firmware update which can be started from any certified Z-Wave controller supporting the Firmware Update Command Class version 3 and above. While updating the device works normally.

Just when the firmware update completes, the device will be inactive for few seconds during self-programming and rebooting.

During the reboot process, the local loads (if present) will be disengaged. Should the firmware update fail, the whole updating process must be re-started from the beginning.

The updating will last from 10 to 30 minutes depending on the network traffic condition.

Factory Default procedure

1. Start the factory default procedure by pressing and holding the hidden button on the front end top-back of the device till the buzzer plays a long beep (5 s).
2. Release the button and press it again till the buzzer plays a sequence of 3 short beeps.
3. The device will revert to its factory default settings, blinking all LED buttons and rebooting.

Do not disconnect the device from the power supply until reboot is completed.

Configuration and settings are restored to default values. "Home ID" and "Node ID" will be cleared as well.

ASSOCIATION/MULTICHANNEL ASSOCIATION

Association enables the device to control other nodes included in the same Z-Wave network for a maximum of **20 nodes** for **each button/group** with max **10 endpoints per Node**.

Group 1 Lifeline Notification

Max 20 associations available, Singlechannel or Multichannel.

Warning: In order to enable a controller to receive notifications with a endpoint source address from a Multichannel device, the controller must be associated to the lifeline group with the Multichannel association command class.

Example: if controller Node ID is 1, MULTICHANNEL ASSOCIATION must be set to the lifeline group 1 with controller nodeID(1) and endpoint(1)

Group 2 Reserved

Group 3 MAX_NODES_IN_GROUP 20

MAX_END_POINTS per Node: 10

Single channel association is only for root device so if used in a Multichannel environment the source and destination endpoint are lost.

Multichannel Association instead contains the Source Endpoint and the Destination Endpoint so the device is addressed correctly.

General Rule for Groups

Each button has a dedicated group starting from #3 so button #1 is referred to **Group 3**, button #2 will control all the devices associated into group number 4 and so on. The number of groups depends on the number of endpoints (buttons). See table below for group association to buttons.

Messages sent by each group to associated devices are related to the "configuration type" of the endpoints.

Group N.	Button N.	Notes
1	-	Lifeline
2	-	Reserved
3	1	Always present
4	2	If present
5	3	If present
6	4	If present
7	5	If present
8	6	If present

PARAMETERS LIST

All parameters depends on their SIZE value. Size can be different from the table below. Before placing a "parameter #, SET value", always ask for a "Parameter #, GET" to retrieve the correct SIZE dimension.

See table below for the complete list of Configuration command Class parameters for all Vitrum products.

Description	Par. N. (Dec)	Size (B)	Value range	Default value
EP Type Button				
EP Type Button N.1 to N.6	1 to 6	1	0-26	Depends on specific device
End Point Type values				
EP_OFF	0			
EP_DIMMER	1		CC SWITCH MULTILEVEL - see par 31 to 36	
EP_SWITCHBUTTON	2		CC BASIC - see par 31 to 36	
EP_PUSHBUTTON	3		CC BASIC - see par 31 to 36	
EP_CURTAIN_1 Button	4		motor control with 1 button	
EP_CURTAIN	5		motor control with 2 buttons	
EP_MASTER_OFF	15		TBC	
EP_CURTAIN_UP	27		motor only up	
EP_CURTAIN_DOWN	28		motor only down	
Button Off Color				
Button N.1 to N.6 Off Color status	7 to 12	1	0-7	3
Button On Color				

Description	Par. N. (Dec)	Size (B)	Value range	Default value
Button N.1 to N.6 On Color status	13 to 18	1	0-7	4
Button Eco Color				
Button N.1 to N.6 Eco Color status	19 to 24	1	0-7	2
Button On/Off/Eco Color values list				
LED_COLOR_OFF	0			
LED_COLOR_RED	1			
LED_COLOR_GREEN	2			
LED_COLOR_BLU	3			
LED_COLOR_YELLOW	4			
LED_COLOR_MAGENTA	5			
LED_COLOR_CYAN	6			
LED_COLOR_WHITE	7			

Button to Output Port connection				
Output Port connected to Button N.1 to N.6	25 to 30	1	0-6	
Output Port				
Not connected to any port	0			
Output Port N.1 to N.6 connected to button	1 to 6			
Basic or Multilevel SET max value type	31 to 36	1	0 = 0x63 (100%) 1 = 0xFF (last level)	0: 0x63

Motors Control Time				
Channel 0 to 2 Motor Control Time (s)	191 to 193	1		60 (60 s)
Channel 0 Motor Control Switch All behavior (*1)	194	1		0
Channel 1 Motor Control Switch All behavior	195	1		0
Channel 2 Motor Control Switch All behavior	196	1		0
Lifeline queue time delay: <i>Add some delay to lifeline notifications</i>	215	2	1= 10 mS 10=100 mS 100=1000 mS	

NWI Enable	216	1	1: NWI enabled, default 0: learn mode classic only	
Multichannel Capability Report notification: Endpoint presentation after multichannel transmission	217	1	0: disabled, default 1: low power 2: Full Power	
Keyboard Lock Outputs and back-light still working 1. Lifeline notification CConfig[218, 1] If a locked button is pressed 2. Force unlock: triple press on button 1 as per inclusion process -> BIP... BIP-BIP	218	1	0: unlock 1: lock	0: unlock
Triac safe mode when an EP is transformed in to curtain the corresponding Triac is disabled (only for triac dev.)	221	1	0:unable 1:disable	N/A

Example of **End Point Type values**:
Button configured as EP_CENTRAL_SCENE. It sends through the Lifeline association group the "Central Scene Notification" commands. (CMD_Key_Pressed, CMD_Key_Released, CMD_Key_Held_Down).
To set an EP_CENTRAL_SCENE use the Configuration command Class parameter 1->6, value 0x1A.

NODE CAPABILITIES

Basic, Generic and Specific Device Class

Informations below Reported from Node Information Frame (NIF)

NIF PARAMETER DESCRIPTOR	LIBRARY IDENTIFIER
Basic Device Class	BASIC_TYPE_ROUTING_SLAVE Routing Slave Enhanced 232
Generic Device Class	GENERIC_TYPE_SWITCH_BINARY
Specific Device Class	SPECIFIC_TYPE_POWER_SWITCH_BINARY

Command Classes

Informations below Reported from:

- Node Information Frame (NIF)
- Version CC, Version Get and Report commands

COMMAND CLASS	LIBRARY IDENTIFIER	VERSION
Z-Wave Plus Info	COMMAND_CLASS_ZWAVEPLUS_INFO	2
Version	COMMAND_CLASS_VERSION	2
Manufacturer Specific	COMMAND_CLASS_MANUFACTURER_SPECIFIC	2
Device Reset Locally	COMMAND_CLASS_DEVICE_RESET_LOCALLY	1
Powerlevel	COMMAND_CLASS_POWERLEVEL	1
Firmware Update Meta Data	COMMAND_CLASS_FIRMWARE_UPDATE_MD	4
Association	COMMAND_CLASS_ASSOCIATION	2
Multi Channel Association	COMMAND_CLASS_MULTI_CHANNEL_ASSOCIATION	3
AGI (Association Gorup Info)	COMMAND_CLASS_ASSOCIATION_GRP_INFO	1
Multi Channel	COMMAND_CLASS_MULTI_CHANNEL	4
Configuration	COMMAND_CLASS_CONFIGURATION	1
Manufacturer Proprietary	COMMAND_CLASS_MANUFACTURER_PROPRIETARY	1
Indicator	COMMAND_CLASS_INDICATOR	1
Node Name and Location	COMMAND_CLASS_NODE_NAMING	1
All Switch	COMMAND_CLASS_SWITCH_ALL	1

COMMAND CLASS MARK

Scene Activation	COMMAND_CLASS_SCENE_ACTIVATION	1
Central Scene	COMMAND_CLASS_CENTRAL_SCENE	1
Multilevel Switch	COMMAND_CLASS_SWITCH_MULTILEVEL	4
Binary Switch	COMMAND_CLASS_SWITCH_BINARY	1
Basic	COMMAND_CLASS_BASIC	1

Command Class Specification

COMMAND CLASS BASIC SET: MAX Value = [0x63 o 0xFF] -> [par31->36]
COMMAND CLASS INDICATOR values 0-7, 0xFF

The version implemented is the #1 and may turn the device as a blinking indicator. The supported values are 0x00 (off/disable) or 0xFF (on/enable) and the field may carry valid values from 1 to 7.

0xFF: StartBlink(ALL_CHANNELS, YELLOW);
0x00: StopBlink(ALL_CHANNELS);

Valid values are:

1: white, 2: blue, 3: green, 4: cyan, 5: red, 6: magenta, 7: yellow

Timeout: ~60s

Generic and Specific Device Class by Curtain Endpoint

Informations below reported from Multi Channel Capability Report Command, valid if endpoint is set as "CURTAIN" only.

PARAMETER DESCRIPTOR	DESCRIPTION	LIBRARY IDENTIFIER
Generic Device Class	Switch Multilevel	GENERIC_TYPE_SWITCH_MULTILEVEL
Specific Device Class	Class A Motor Control	SPECIFIC_TYPE_CLASS_A_MOTOR_CONTROL

SUPPORTED COMMAND CLASS BY ENDPOINT

Informations below reported from Multi Channel Capability Report Command:

COMMAND CLASS	LIBRARY IDENTIFIER	VERSION
Binary	COMMAND_CLASS_SWITCH_BINARY	1
Multilevel Switch	COMMAND_CLASS_SWITCH_MULTILEVEL	4

DYNAMIC ENDPOINT EXPLANATION

Endpoints 1, 2, 3, set as "CURTAIN", are linked with endpoints 4, 5, 6 in vertical pairs, so endpoint 1 (direction up) is linked to endpoint 4 (direction down), and so on. Therefore endpoint 4, 5, 6, will not be "INTEROPERABLE" if a multichannel capability get is requested.

The valid endpoint association groups will be only 3, 4, 5. Relevant parameters are 191-196.

SPECIFICATIONS

Manufacturer ID: 0x010A

Models and Frequencies

REGION	CODE	FREQUENCY	PRODUCT TYPE ID	PRODUCT ID	APP ID
EU	01B02H020	868.4 Mhz	0x7115	0x1016	0x0215
IL	01BE20020	916 Mhz	0x7006	0x0F07	0x0106
KR	01BB2H020	921.4 Mhz	0x7116	0x1017	0x0216

Technical Specifications

Operating voltage	230 VAC 50 Hz
Consumption	<1.5W standby
Operating temperature	from 0°C to +40°C
Operating Humidity	20% - 90% RH non condensing
Storage temperature	from -40°C to +55°C
Storage Humidity	10% - 93% RH non condensing
IP Class	IP20
Package Dimension (W x H x D)	135 x 50 x 170 mm
Weight	~210 gr
RF radiated powered	2.5 mW (max)
RF range	Up to 40 m open range
Warranty	1 year

INSTALLATION

Wire the device according to the schematic below.

- L Power connection (LIVE)
- N Power connection (Neutral)

Position the device in the wall's mounting box and check cables are not interfering with the device case. Using the appropriate screw set that matches the wall box, fix the device in place without applying unnecessary torque to fixing screws.

Choosing a suitable location

Do not locate the device facing direct sunlight, humid or dusty place. The suitable ambient temperature is listed in specification.

Do not locate the device where there are any combustible substances or sources of heat (e.g. fires, radiators, boiler, etc.).

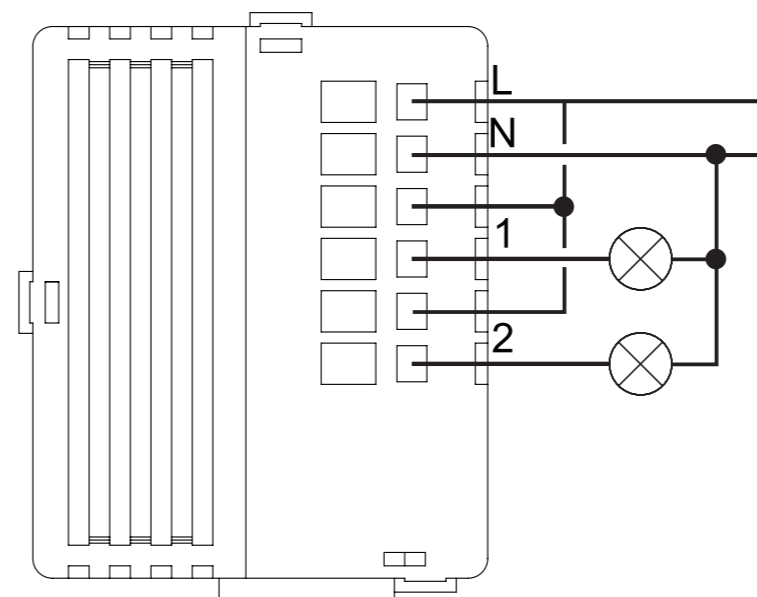

FUNCTIONS

Buttons and LEDs are numbered according the picture below facing front the device.

Each button has an RGB back-light LED that shows different colours during normal operation and certain sequence are also used to report special status.

Button #1 is used as **z-wave network button**

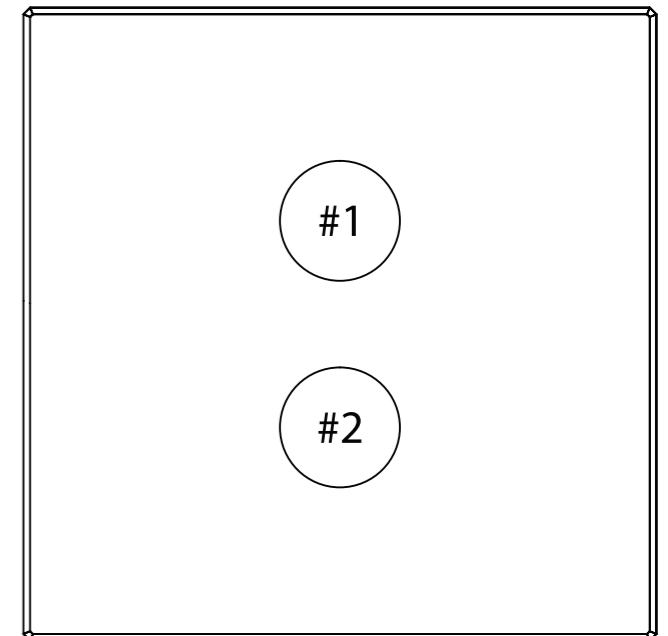

Special condition or status

LED	Colour codes	Description
LED #1	<i>blinks green for 5s</i>	<i>Valid HW signature detected at boot</i>
	<i>blinks red for 5s</i>	<i>Invalid HW signature detected at boot</i>
	<i>red glitch</i>	<i>When button #1 is touched indicates device is NOT included in the Z-Wave network</i>
	<i>Steady red</i>	<i>HW fault, contact assistance</i>

Normal operating condition or status

LED	Colour codes	Description
Any LED	<i>Steady blue</i>	<i>BASIC off or MULTILEVEL 0%</i>
	<i>Steady green</i>	<i>light dimming MULTILEVEL set at 33%</i>
	<i>Steady yellow</i>	<i>MULTILEVEL set at 100% or BASIC on</i>
	<i>Steady magenta</i>	<i>MOTOR control</i>

STANDARDS AND REGULATIONS

Electrical safety	(LVD) 2014/35/EU
Electromagnetic compatibility	(EMC) 2014/30/EU
Radio	(RED) 2014/53/EU
Presence of hazardous substances	(RoHS II) 2011/65/EU
Waste electrical and electronic equipment	(WEEE) 2012/19/EU

List of harmonized regulations applied

EN 301 489-1 V1.9.2; EN 301 489-3 V1.6.1
EN 50491-5-1:2010; EN 50491-5-2:2010
EN 60669-1:2000; EN 60669-1/A1:2003; EN60669-1/A2:2009
EN 60669-2-1:2004; EN 60669-2-1/A1:2009; EN 60669-2-1/A12:2009
EN 62479: 2010
EN 300 220-2 V.2.4.1





Model: WallZ-BS
Type: 4CH-2RL
Code: 01B04H015
Protocol: Z-Wave Plus

INTRODUCTION

Purpose of this document

This manual describes the most essential functions and technical specifications to help the electrician to install, setup and control the device. It is a Z-Wave Plus device of the Vitrum 2.0 product range. Visit our website for the complete list.

This document is also available on our web-site.

Notice

Dispose cardboard box & holder, plastic bags and front plastic shell according to local recycling regulation. Box and holder are PAP recyclable, plastic bags are LDPE, front shell is PP.

Safety

Take care of your safety. Use only insulated tools and remove power from the mains circuit breakers before and during any installation activity.

Caution

This device is a permanently connected to the mains thus implies it is mandatory to have a readily accessible disconnect device (like a circuit breaker) incorporated in the general wiring of the building with at least 3mm separation between contacts.

Danger: Risk of electrocution

Device installation and maintenance must be carried out by trained and skilled electricians in accordance with local wiring and building regulations. The device has no basic insulation and must never be used without the front glass plate. It must be installed in a way that protect from accidental contact. During installation procedure, the dummy plastic cover must be left on.

Before and during installation disconnect mains power.

Before you start

You will need available and ready to use:

- Small Phillips isolated screw driver
- Small slotted isolated driver (alternate)

Package content

- 1 x Wall mountable device
- 2 x Metric screw set
- 2 x Plastic screw set
- 1 x Protective shell

Preparation

Remove carefully the device from the cardboard support. Keep this manual for further reference.

Features

Touch operated button with RGB back-light.
 Based on Z-Wave[®] 500 module for wider coverage and higher data rate.
 Very low power consumption in standby.
 Easy installation.
 Acoustic feedback at button press.
 Over-the-air firmware update.

Z-WAVE NETWORKING

This product can be included and operates in any Z-Wave network with other Z-Wave certified devices from other manufacturers and/or other applications. This device is an always powered node and within the network will act as repeater regardless of vendor to increase reliability of the network.

ADD (inclusion)

The device supports both Normal Inclusion and Network Wide Inclusion.

Follow the steps below to include the device into the network:

1. Check the device is not already included in a Z-Wave network by pressing any button on the front panel: the LED button should blink with red colour shortly. Should the device be already included, follow the instructions below to excluded it from the network.
2. Set the controller into "Inclusion Mode". Refer to the controller documentation to set the controller into Inclusion mode.
3. Set the device into Learn Mode by pressing and holding button No.1 (on the top left of the device) for longer than 4 seconds. The device will enter into inclusion mode by blinking magenta LED button No.1. Upon successful completion, the device LEDs will blink green three times.
4. Should for any reasons the device fail the normal inclusion, the device turns to enter into the Network Wide Inclusion Mode up to 4 times. Any time the device enters into Wide Inclusion Mode, LED Button No.1 blinks Magenta.

REMOVE (exclusion)

Before starting to exclude the device from the network set the controller into "Exclusion Mode". Please refer to the controller documentation to set the controller into Exclusion mode.

The device can be excluded from a network only if previously included. Check that by pressing a button on the front panel: the LED button should not blink with red colour shortly.

Follow the steps below to exclude the device from the network:

1. Press and hold button No.1 (on the top left of the front panel device) for around 6 seconds and after that press 3 times the same button shortly within 3 seconds.
2. LED Button No.1 blinks red upon completely the device exclusion successfully.
3. Check the device is removed from the network by pressing button No.1: the LED button blinks red shortly.

Node Info Frame

To send a Node info frame press and release shortly the *HIDDEN BUTTON* (see picture on Installation paragraph) on the front end top-back of the device; a short audio signal (*beep*), will confirm the Node Info transmission.

If parameter 217 is set at 1 or 2 (see parameter table below), each button send a "Multichannel Capability Report". As default, parameter 217 is OFF.

Firmware Update

This device supports the firmware update which can be started from any certified Z-Wave controller supporting the Firmware Update Command Class version 3 and above. While updating the device works normally.

Just when the firmware update completes, the device will be inactive for few seconds during self-programming and rebooting.

During the reboot process, the local loads (if present) will be disengaged. Should the firmware update fail, the whole updating process must be re-started from the beginning.

The updating will last from 10 to 30 minutes depending on the network traffic condition.

Factory Default procedure

1. Start the factory default procedure by pressing and holding the hidden button on the front end top-back of the device till the buzzer plays a long beep (5 s).
2. Release the button and press it again till the buzzer plays a sequence of 3 short beeps.
3. The device will revert to its factory default settings, blinking all LED buttons and rebooting.

Do not disconnect the device from the power supply until reboot is completed.

Configuration and settings are restored to default values. "Home ID" and "Node ID" will be cleared as well.

ASSOCIATION/MULTICHANNEL ASSOCIATION

Association enables the device to control other nodes included in the same Z-Wave network for a maximum of **20 nodes** for **each button/group** with max **10 endpoints per Node**.

Group 1 Lifeline Notification

Max 20 associations available, Singlechannel or Multichannel.

Warning: In order to enable a controller to receive notifications with a endpoint source address from a Multichannel device, the controller must be associated to the lifeline group with the Multichannel association command class.

Example: if controller Node ID is 1, MULTICHANNEL ASSOCIATION must be set to the lifeline group 1 with controller nodeID(1) and endpoint(1)

Group 2 Reserved

Group 3 MAX_NODES_IN_GROUP 20

MAX_END_POINTS per Node: 10

Single channel association is only for root device so if used in a Multichannel environment the source and destination endpoint are lost. Multichannel Association instead contains the Source Endpoint and the Destination Endpoint so the device is addressed correctly.

General Rule for Groups

Each button has a dedicated group starting from #3 so button #1 is referred to **Group 3**, button #2 will control all the devices associated into group number 4 and so on. The number of groups depends on the number of endpoints (buttons). See table below for group association to buttons.

Messages sent by each group to associated devices are related to the "configuration type" of the endpoints.

Group N.	Button N.	Notes
1	-	Lifeline
2	-	Reserved
3	1	Always present
4	2	If present
5	3	If present
6	4	If present
7	5	If present
8	6	If present

PARAMETERS LIST

All parameters depends on their SIZE value. Size can be different from the table below. Before placing a "parameter #, SET value", always ask for a "Parameter #, GET" to retrieve the correct SIZE dimension.

See table below for the complete list of Configuration command Class parameters for all Vitrum products.

Description	Par. N. (Dec)	Size (B)	Value range	Default value
EP Type Button				
EP Type Button N.1 to N.6	1 to 6	1	0-26	Depends on specific device
End Point Type values				
EP_OFF			0	
EP_DIMMER			1 CC SWITCH MULTILEVEL - see par 31 to 36	
EP_SWITCHBUTTON			2 CC BASIC - see par 31 to 36	
EP_PUSHBUTTON			3 CC BASIC - see par 31 to 36	
EP CURTAIN_1 Button			4 motor control with 1 button	
EP_CURTAIN			5 motor control with 2 buttons	
EP_MASTER_OFF			15 TBC	
EP CURTAIN_UP			27 motor only up	
EP CURTAIN_DOWN			28 motor only down	
Button Off Color				
Button N.1 to N.6 Off Color status	7 to 12	1	0-7	3
Button On Color				

Description	Par. N. (Dec)	Size (B)	Value range	Default value
Button N.1 to N.6 On Color status	13 to 18	1	0-7	4
Button Eco Color				
Button N.1 to N.6 Eco Color status	19 to 24	1	0-7	2
Button On/Off/Eco Color values list				
LED_COLOR_OFF	0			
LED_COLOR_RED	1			
LED_COLOR_GREEN	2			
LED_COLOR_BLU	3			
LED_COLOR_YELLOW	4			
LED_COLOR_MAGENTA	5			
LED_COLOR_CYAN	6			
LED_COLOR_WHITE	7			

Button to Output Port connection				
Output Port connected to Button N.1 to N.6	25 to 30	1	0-6	
Output Port				
Not connected to any port	0			
Output Port N.1 to N.6 connected to button	1 to 6			
Basic or Multilevel SET max value type	31 to 36	1	0 = 0x63 (100%) 1 = 0xFF (last level)	0: 0x63

Motors Control Time				
Channel 0 to 2 Motor Control Time (s)	191 to 193	1		60 (60 s)
Channel 0 Motor Control Switch All behavior (*1)	194	1		0
Channel 1 Motor Control Switch All behavior	195	1		0
Channel 2 Motor Control Switch All behavior	196	1		0
Lifeline queue time delay: <i>Add some delay to lifeline notifications</i>	215	2	1= 10 mS 10=100 mS 100=1000 mS	
NWI Enable	216	1	1: NWI enabled, default 0: learn mode classic only	

Multichannel Capability Report notification: Endpoint presentation after multichannel transmission	217	1	0: disabled, default 1: low power 2: Full Power	
Keyboard Lock Outputs and back-light still working 1. Lifeline notification CCConfig[218, 1] If a locked button is pressed 2. Force unlock: triple press on button 1 as per inclusion process -> BIP... BIP-BIP	218	1	0: unlock 1: lock	0: unlock
Triac safe mode when an EP is transformed in to curtain the corresponding Triac is disabled (only for triac dev.)	221	1	0:unable 1:disable	N/A

Example of End Point Type values:
 Button configured as EP_CENTRAL_SCENE. It sends through the Lifeline association group the "Central Scene Notification" commands. (CMD_Key_Pressed, CMD_Key_Released, CMD_Key_Held_Down).
 To set an EP_CENTRAL_SCENE use the Configuration command Class parameter 1->6, value 0x1A.

NODE CAPABILITIES

Basic, Generic and Specific Device Class

Informations below Reported from Node Information Frame (NIF)

NIF PARAMETER DESCRIPTOR	LIBRARY IDENTIFIER
Basic Device Class	BASIC_TYPE_ROUTING_SLAVE Routing Slave Enhanced 232
Generic Device Class	GENERIC_TYPE_SWITCH_BINARY
Specific Device Class	SPECIFIC_TYPE_POWER_SWITCH_BINARY

Command Classes

Informations below Reported from:

- Node Information Frame (NIF)
- Version CC, Version Get and Report commands

COMMAND CLASS	LIBRARY IDENTIFIER	VERSION
Z-Wave Plus Info	COMMAND_CLASS_ZWAVEPLUS_INFO	2
Version	COMMAND_CLASS_VERSION	2
Manufacturer Specific	COMMAND_CLASS_MANUFACTURER_SPECIFIC	2
Device Reset Locally	COMMAND_CLASS_DEVICE_RESET_LOCALLY	1
Powerlevel	COMMAND_CLASS_POWERLEVEL	1
Firmware Update Meta Data	COMMAND_CLASS_FIRMWARE_UPDATE_MD	4
Association	COMMAND_CLASS_ASSOCIATION	2
Multi Channel Association	COMMAND_CLASS_MULTI_CHANNEL_ASSOCIATION	3
AGI (Association Gorup Info)	COMMAND_CLASS_ASSOCIATION_GRP_INFO	1
Multi Channel	COMMAND_CLASS_MULTI_CHANNEL	4
Configuration	COMMAND_CLASS_CONFIGURATION	1
Manufacturer Proprietary	COMMAND_CLASS_MANUFACTURER_PROPRIETARY	1
Indicator	COMMAND_CLASS_INDICATOR	1
Node Name and Location	COMMAND_CLASS_NODE_NAMING	1
All Switch	COMMAND_CLASS_SWITCH_ALL	1

COMMAND CLASS MARK		
Scene Activation	COMMAND_CLASS_SCENE_ACTIVATION	1
Central Scene	COMMAND_CLASS_CENTRAL_SCENE	1
Multilevel Switch	COMMAND_CLASS_SWITCH_MULTILEVEL	4
Binary Switch	COMMAND_CLASS_SWITCH_BINARY	1
Basic	COMMAND_CLASS_BASIC	1

Command Class Specification

COMMAND CLASS BASIC SET: MAX Value = [0x63 o 0xFF] -> [par31->36]
 COMMAND CLASS INDICATOR values 0-7, 0xFF

The version implemented is the #1 and may turn the device as a blinking indicator. The supported values are 0x00 (off/disable) or 0xFF (on/enable) and the field may carry valid values from 1 to 7.

0xFF: StartBlink(ALL_CHANNELS, YELLOW);
 0x00: StopBlink(ALL_CHANNELS);

Valid values are:

1: white, 2: blue, 3: green, 4: cyan, 5: red, 6: magenta, 7: yellow

Timeout: ~60s

Generic and Specific Device Class by Curtain Endpoint

Informations below reported from Multi Channel Capability Report Command, valid if endpoint is set as "CURTAIN" only.

PARAMETER DESCRIPTOR	DESCRIPTION	LIBRARY IDENTIFIER
Generic Device Class	Switch Multilevel	GENERIC_TYPE_SWITCH_MULTILEVEL
Specific Device Class	Class A Motor Control	SPECIFIC_TYPE_CLASS_A_MOTOR_CONTROL

SUPPORTED COMMAND CLASS BY ENDPOINT

Informations below reported from Multi Channel Capability Report Command:

COMMAND CLASS	LIBRARY IDENTIFIER	VERSION
Binary	COMMAND_CLASS_SWITCH_BINARY	1
Multilevel Switch	COMMAND_CLASS_SWITCH_MULTILEVEL	4

DYNAMIC ENDPOINT EXPLANATION

Endpoints 1, 2, 3, set as "CURTAIN", are linked with endpoints 4, 5, 6 in vertical pairs, so endpoint 1 (direction up) is linked to endpoint 4 (direction down), and so on. Therefore endpoint 4, 5, 6, will not be "INTEROPERABLE" if a multichannel capability get is requested.

The valid endpoint association groups will be only 3, 4, 5. Relevant parameters are 191-196.

SPECIFICATIONS

Manufacturer ID: 0x010A

Models and Frequencies

REGION	CODE	FREQUENCY	PRODUCT TYPE ID	PRODUCT ID	APP ID
EU	01B04H015	868.4 Mhz	0x7115	0x1016	0x0215
IL	01BE40010	916 Mhz	0x7006	0x0F07	0x0106
KR	01BB4H010	921.4 Mhz	0x7116	0x1017	0x0216

Technical Specifications

Operating voltage	230 VAC 50 Hz
Consumption	<1.5W standby
Operating temperature	from 0°C to +40°C
Operating Humidity	20% - 90% RH non condensing
Storage temperature	from -40°C to +55°C
Storage Humidity	10% - 93% RH non condensing
IP Class	IP20
Package Dimension (W x H x D)	135 x 50 x 170 mm
Weight	~210 gr
RF radiated powered	2.5 mW (max)
RF range	Up to 40 m open range
Warranty	1 year

INSTALLATION

Wire the device according to the schematic below.

- L Power connection (LIVE)
- N Power connection (Neutral)

Position the device in the wall's mounting box and check cables are not interfering with the device case. Using the appropriate screw set that matches the wall box, fix the device in place without applying unnecessary torque to fixing screws.

Choosing a suitable location

Do not locate the device facing direct sunlight, humid or dusty place. The suitable ambient temperature is listed in specification.

Do not locate the device where there are any combustible substances or sources of heat (e.g. fires, radiators, boiler, etc.).

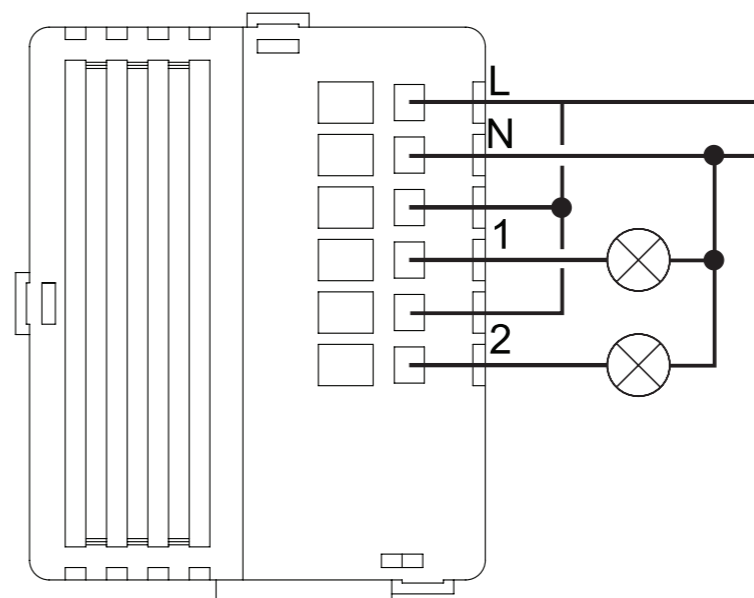

FUNCTIONS

Buttons and LEDs are numbered according the picture below facing front the device.

Each button has an RGB back-light LED that shows different colours during normal operation and certain sequence are also used to report special status.

Button #1 is used as **z-wave network button**

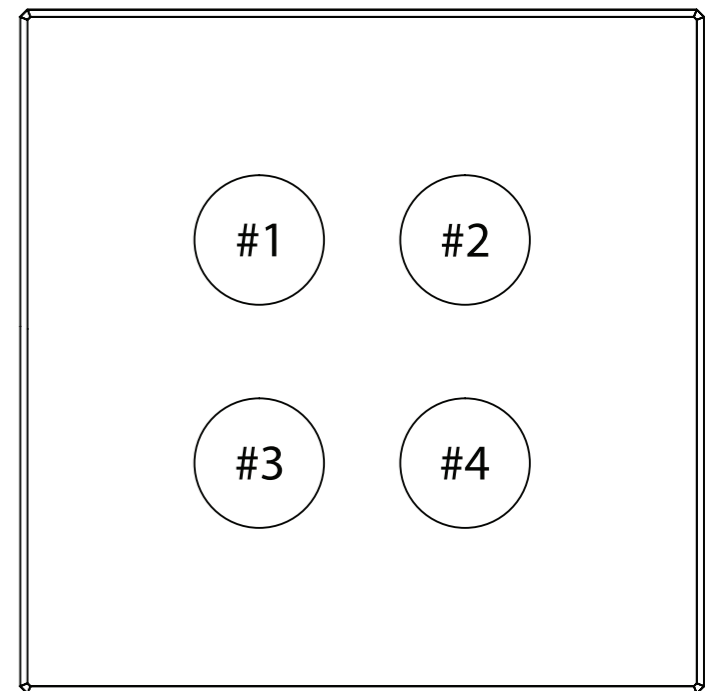

Special condition or status

LED	Colour codes	Description
LED #1	<i>blinks green for 5s</i>	<i>Valid HW signature detected at boot</i>
	<i>blinks red for 5s</i>	<i>Invalid HW signature detected at boot</i>
	<i>red glitch</i>	<i>When button #1 is touched indicates device is NOT included in the Z-Wave network</i>
	<i>Steady red</i>	<i>HW fault, contact assistance</i>

Normal operating condition or status

LED	Colour codes	Description
Any LED	<i>Steady blue</i>	<i>BASIC off or MULTILEVEL 0%</i>
	<i>Steady green</i>	<i>light dimming MULTILEVEL set at 33%</i>
	<i>Steady yellow</i>	<i>MULTILEVEL set at 100% or BASIC on</i>
	<i>Steady magenta</i>	<i>MOTOR control</i>

STANDARDS AND REGULATIONS

Electrical safety	(LVD) 2014/35/EU
Electromagnetic compatibility	(EMC) 2014/30/EU
Radio	(RED) 2014/53/EU
Presence of hazardous substances	(RoHS II) 2011/65/EU
Waste electrical and electronic equipment	(WEEE) 2012/19/EU

List of harmonized regulations applied

EN 301 489-1 V1.9.2; EN 301 489-3 V1.6.1
 EN 50491-5-1:2010; EN 50491-5-2:2010
 EN 60669-1:2000; EN 60669-1/A1:2003; EN60669-1/A2:2009
 EN 60669-2-1:2004; EN 60669-2-1/A1:2009; EN 60669-2-1/A12:2009
 EN 62479: 2010
 EN 300 220-2 V.2.4.1



Model: WallZ-BS
Type: Therm-0
Code: 02B00H010
Protocol: Z-Wave Plus

INTRODUCTION

Purpose of this document

This manual describes the most essential functions and technical specifications to help the electrician to install, setup and control the device. It is a Z-Wave Plus device of the Vitrum 2.0 product range. Visit our website for the complete list.

This document is also available on our web-site.

Notice

Dispose cardboard box & holder, plastic bags and front plastic shell according to local recycling regulation. Box and holder are PAP recyclable, plastic bags are LDPE, front shell is PP.

Safety

Take care of your safety. Use only insulated tools and remove power from the mains circuit breakers before and during any installation activity.

Caution

This device is a permanently connected to the mains thus implies it is mandatory to have a readily accessible disconnect device (like a circuit breaker) incorporated in the general wiring of the building with at least 3mm separation between contacts.

Danger: Risk of electrocution

Device installation and maintenance must be carried out by trained and skilled electricians in accordance with local wiring and building regulations. The device has no basic insulation and must never be used without the front glass plate. It must be installed in a way that protect from accidental contact. During installation procedure, the dummy plastic cover must be left on.

Before and during installation disconnect mains power.

Before you start

You will need available and ready to use:

- Small Phillips isolated screw driver
- Small slotted isolated driver (alternate)

Package content

- 1 x Wall mountable device
- 2 x Metric screw set
- 2 x Plastic screw set
- 1 x Protective shell

Preparation

Remove carefully the device from the cardboard support. Keep this manual for further reference.

Features

Touch operated button with RGB back-light.
 Based on Z-Wave [®] 500 module for wider coverage and higher data rate.
 Very low power consumption in standby.
 Easy installation.
 Acoustic feedback at button press.
 Over-the-air firmware update.

Z-WAVE NETWORKING

This product can be included and operates in any Z-Wave network with other Z-Wave certified devices from other manufacturers and/or other applications. This device is an always powered node and within the network will act as repeater regardless of vendor to increase reliability of the network.

ADD (inclusion)

The device supports both Normal Inclusion and Network Wide Inclusion.

Follow the steps below to include the device into the network:

1. Check the device is not already included in a Z-Wave network by pressing any button on the front panel: the LED button should blink with red colour shortly. Should the device be already included, follow the instructions below to excluded it from the network.
2. Set the controller into "Inclusion Mode". Refer to the controller documentation to set the controller into Inclusion mode.
3. Set the device into Learn Mode by pressing and holding button No.1 (on the top left of the device) for longer than 4 seconds. The device will enter into inclusion mode by blinking magenta LED button No.1. Upon successful completion, the device LEDs will blink green three times.
4. Should for any reasons the device fail the normal inclusion, the device turns to enter into the Network Wide Inclusion Mode up to 4 times. Any time the device enters into Wide Inclusion Mode, LED Button No.1 blinks Magenta.

REMOVE (exclusion)

Before starting to exclude the device from the network set the controller into "Exclusion Mode". Please refer to the controller documentation to set the controller into Exclusion mode.

The device can be excluded from a network only if previously included. Check that by pressing a button on the front panel: the LED button should not blink with red colour shortly.

Follow the steps below to exclude the device from the network:

1. Press and hold button No.1 (on the top left of the front panel device) for around 6 seconds and after that press 3 times the same button shortly within 3 seconds.
2. LED Button No.1 blinks red upon completely the device exclusion successfully.
3. Check the device is removed from the network by pressing button No.1: the LED button blinks red shortly.

Node Info Frame

To send a Node info frame press and release shortly the *HIDDEN BUTTON* (see picture on Installation paragraph) on the front end top-back of the device; a short audio signal (*beep*), will confirm the Node Info transmission.

If parameter 217 is set at 1 or 2 (see parameter table below), each button send a "Multichannel Capability Report". As default, parameter 217 is OFF.

Firmware Update

This device supports the firmware update which can be started from any certified Z-Wave controller supporting the Firmware Update Command Class version 3 and above. While updating the device works normally.

Just when the firmware update completes, the device will be inactive for few seconds during self-programming and rebooting.

During the reboot process, the local loads (if present) will be disengaged. Should the firmware update fail, the whole updating process must be re-started from the beginning.

The updating will last from 10 to 30 minutes depending on the network traffic condition.

Factory Default procedure

1. Start the factory default procedure by pressing and holding the hidden button on the front end top-back of the device till the buzzer plays a long beep (5 s).
2. Release the button and press it again till the buzzer plays a sequence of 3 short beeps.
3. The device will revert to its factory default settings, blinking all LED buttons and rebooting.

Do not disconnect the device from the power supply until reboot is completed.

Configuration and settings are restored to default values. "Home ID" and "Node ID" will be cleared as well.

ASSOCIATION/MULTICHANNEL ASSOCIATION

Association enables the device to control other nodes included in the same Z-Wave network for a maximum of **20 nodes** for **each button/group** with max **10 endpoints per Node**.

Group 1 Lifeline Notification

Max 20 associations available, Singlechannel or Multichannel.

Warning: In order to enable a controller to receive notifications with a endpoint source address from a Multichannel device, the controller must be associated to the lifeline group with the Multichannel association command class.

Example: if controller Node ID is 1, MULTICHANNEL ASSOCIATION must be set to the lifeline group 1 with controller nodeID(1) and endpoint(1)

Group 2 Reserved

Group 3 MAX_NODES_IN_GROUP 20

MAX_END_POINTS per Node: 10

Single channel association is only for root device so if used in a Multichannel environment the source and destination endpoint are lost. Multichannel Association instead contains the Source Endpoint and the Destination Endpoint so the device is addressed correctly.

General Rule for Groups

Each button has a dedicated group starting from #3 so button #1 is referred to **Group 3**, button #2 will control all the devices associated into group number 4 and so on. The number of groups depends on the number of endpoints (buttons). See table below for group association to buttons.

Messages sent by each group to associated devices are related to the "configuration type" of the endpoints.

Group N.	Button N.	Notes
1	-	Lifeline
2	-	Reserved
3	1	Always present
4	2	If present
5	3	If present
6	4	If present
7	5	If present
8	6	If present

GROUP NAME	MAX NODES	DESCRIPRION
Lifeline	20	Send 'Thermostat Mode Report' command every time the Thermostat mode status has changed; Send Thermostat 'Set Point Report' command every time the Set Point value has changed; Send 'Fan Mode Report' command every time Fan Mode status has changed; Send 'Basic Report' command every time a Basic Set from Heating Valve and Cooling Valve groups has been sent; Send 'Binary Switch Report' command every time: • the local relay on board has been switched on/of • the Set Point Mode button has been pressed • the remote heating or cooling valve has been 'Binary Switch Set' Send 'Device Reset Locally Notification' to report Factory Reset event.
Sensor multi-level get	20	Send 'Sensor Multilevel Get' to report temperature from a sensor device
Fan mode	20	Send 'Fan Mode Set' command every time Fan Mode button is pressed
Thermostat mode	20	Send 'Thermostat Mode Set' command every time the Thermostat mode has changed
Set point	20	Send 'Thermostat Set Point Set' command every time the Set Point has changed

Set point	20	Send 'Binary Switch Set' ON/OFF command to an heating valve
Cooling Valve	20	Send 'Binary Switch Set' ON/OFF command to an cooling valve
Switch Multi-level	20	Send 'Switch Multilevel Set' command according to Fans Coil speed to reach
Binary Switch	20	Send 'Binary Switch Set' ON every time button N.2 is pressed

CONFIGURATION

Parameter name	Default value	Size	Value range
Output port Heating	0	1	0: Disconnected 1: Output driven by heating algorithm
Output port Cooling	0	1	2: Output driven by cooling algorithm Remark: connecting to an output port already connected, will force the previously connected one to be automatically disconnected
Setpoint Step	50	1	1, 10, 20, 50, 100 cents of degree
Max Setpoint Value	3500	2	0-65535 cents of degree
Min Setpoint Value	1000	2	0-65535 cents of degree
Thermostat Operating Mode	0	1	0: Hotel Mode 1: Home Mode 2: Display Only Mode
Temperature Unit Display Mode	0	1	0: Celsius 1: Fahrenheit 2: Clock
Temperature Button Display Mode	0	1	0: Set Point and Temperature 1: Temperature and Setpoint 2: Clock and Temperature
Display status	0	1	0: AUTO, FAN1, FAN2, FAN3 1-15: Other settings
Fan Coil Button Display Mode	0	1	0: OFF 1: hyphens 2: Temperature
Temperature Unit Display Mode	0	1	0: Always Celsius 1: Always Fahrenheit 2: According to user setting (see OPERATING) or par. N.118 setting
Switch display on remote setting	0	1	0: Display stays of 1: Turns on display upon receiving a remote setting
Min Temperature Deviation	5	1	1-254 Min temperature deviation to be reported on lifeline
Thermostat Of state Forced Ventilation	0	1	0: Disabled 1: Enabled
FAN Speed Change delay	2	1	0-10 s delay to switch fan speed
PID Gain	25	1	0-255
PID Integral Time	15	1	0-255 minutes
PID Dead Band	10	1	0-255 Tens of degree
PID 4-Pipe Heating System Band	16	1	0-255 Tens of degree
PID Fan Coil Speed 2 Threshold	3333	2	From 1 to "PID Fan Coil Speed 3 Threshold"
PID Fan Coil Speed 3 Threshold	6666	2	From "PID Fan Coil Speed 2 Threshold" to 10000

Fan Coil Speed Hysteresis	650	2	From 0 to "PID Fan Coil Speed 2 Threshold" (Default 650 is 6,5% of 10K)
PID 0-10V Fan Coil Min Voltage Output	0	1	From 0 to "0-10V Fan Coil Max Voltage Output"
PID 0-10V Fan Coil Max Voltage Output	100	1	From "0-10V Fan Coil Min Voltage" to 100
Heating System Hysteresis Band	4	1	0-255 Cents of degree
Sampling Time	10	1	1-255 s
Buttons Max. Brightness	100	1	From "Buttons Min. Brightness" to 100
Buttons Min. Brightness	5	1	From 0 to "Buttons Max. Brightness"
Buzzer	1	1	0: disabled 1: enabled
Front-end Buttons lock	0	1	0: disabled 1: enabled

Command Classes

Informations below Reported from:

- Node Information Frame (NIF)
- Version CC, Version Get and Report commands

COMMAND CLASS	LIBRARY IDENTIFIER	VERSION
Z-Wave Plus Info	COMMAND_CLASS_ZWAVEPLUS_INFO	2
Version	COMMAND_CLASS_VERSION	2
Manufacturer Specific	COMMAND_CLASS_MANUFACTURER_SPECIFIC	2
Device Reset Locally	COMMAND_CLASS_DEVICE_RESET_LOCALLY	1
Powerlevel	COMMAND_CLASS_POWERLEVEL	1
Firmware Update Meta Data	COMMAND_CLASS_FIRMWARE_UPDATE_MD	4
Association	COMMAND_CLASS_ASSOCIATION	2
Multi Channel Association	COMMAND_CLASS_MULTI_CHANNEL_ASSOCIATION	3
AGI (Association Gorup Info)	COMMAND_CLASS_ASSOCIATION_GRP_INFO	1
Multi Channel	COMMAND_CLASS_MULTI_CHANNEL	4
Configuration	COMMAND_CLASS_CONFIGURATION	1
Manufacturer Proprietary	COMMAND_CLASS_MANUFACTURER_PROPRIETARY	1
Indicator	COMMAND_CLASS_INDICATOR	1
Node Name and Location	COMMAND_CLASS_NODE_NAMING	1
All Switch	COMMAND_CLASS_SWITCH_ALL	1

COMMAND CLASS MARK	LIBRARY IDENTIFIER	VERSION
Scene Activation	COMMAND_CLASS_SCENE_ACTIVATION	1
Central Scene	COMMAND_CLASS_CENTRAL_SCENE	1
Multilevel Switch	COMMAND_CLASS_SWITCH_MULTILEVEL	4
Binary Switch	COMMAND_CLASS_SWITCH_BINARY	1
Basic	COMMAND_CLASS_BASIC	1

Command Class Specification

COMMAND CLASS BASIC SET: MAX Value = [0x63 o 0xFF] -> [par31->36]
COMMAND CLASS INDICATOR values 0-7,0xFF

The version implemented is the #1 and may turn the device as a blinking indicator. The supported values are 0x00 (off/disable) or 0xFF (on/enable) and the field may carry valid values from 1 to 7.

0xFF: StartBlink(ALL_CHANNELS, YELLOW);
0x00: StopBlink(ALL_CHANNELS);

Valid values are:

1: white, 2: blue, 3: green, 4: cyan, 5: red, 6: magenta, 7: yellow

Timeout: ~60s

Generic and Specific Device Class by Curtain Endpoint

Informations below reported from Multi Channel Capability Report Command, valid if endpoint is set as "CURTAIN" only.

PARAMETER DESCRIPTOR	DESCRIPTION	LIBRARY IDENTIFIER
Generic Device Class	Switch Multilevel	GENERIC_TYPE_SWITCH_MULTILEVEL
Specific Device Class	Class A Motor Control	SPECIFIC_TYPE_CLASS_A_MOTOR_CONTROL

SUPPORTED COMMAND CLASS BY ENDPOINT

Informations below reported from Multi Channel Capability Report Command:

COMMAND CLASS	LIBRARY IDENTIFIER	VERSION
Binary	COMMAND_CLASS_SWITCH_BINARY	1
Multilevel Switch	COMMAND_CLASS_SWITCH_MULTILEVEL	4

DYNAMIC ENDPOINT EXPLANATION

Endpoints 1, 2, 3, set as "CURTAIN", are linked with endpoints 4, 5, 6 in vertical pairs, so endpoint 1 (direction up) is linked to endpoint 4 (direction down), and so on. Therefore endpoint 4, 5, 6, will not be "INTEROPERABLE" if a multichannel capability get is requested.

The valid endpoint association groups will be only 3, 4, 5. Relevant parameters are 191-196.

SPECIFICATIONS

Manufacturer ID: 0x010A

Models and Frequencies

REGION	CODE	FREQUENCY	PRODUCT TYPE ID	PRODUCT ID	APP ID
EU	01B01H020	868.4 Mhz	0x7115	0x1016	0x0215
IL	01Be10020	916 Mhz	0x7006	0x0F07	0x0106
KR	01BB1H020	921.4 Mhz	0x7116	0x1017	0x0216

Technical Specifications

Operating voltage	230 VAC 50 Hz
Consumption	<1.5W standby
Operating temperature	from 0°C to +40°C
Operating Humidity	20% - 90% RH non condensing
Storage temperature	from -40°C to +55°C
Storage Humidity	10% - 93% RH non condensing
IP Class	IP20
Package Dimension (W x H x D)	
Weight	~210 gr
RF radiated powered	2.5 mW (max)
RF range	Up to 40 m open range
Warranty	1 year

INSTALLATION

Wire the device according to the schematic below.

L Power connection (LIVE)
N Power connection (Neutral)

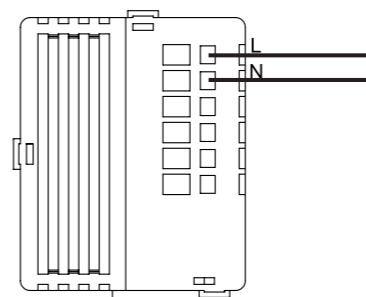

FUNCTIONS

Buttons and LEDs are numbered according the picture below facing front the device.

Each button has an RGB back-light LED that shows different colours during normal operation and certain sequence are also used to report special status.

Button #1 is used as **z-wave network button**

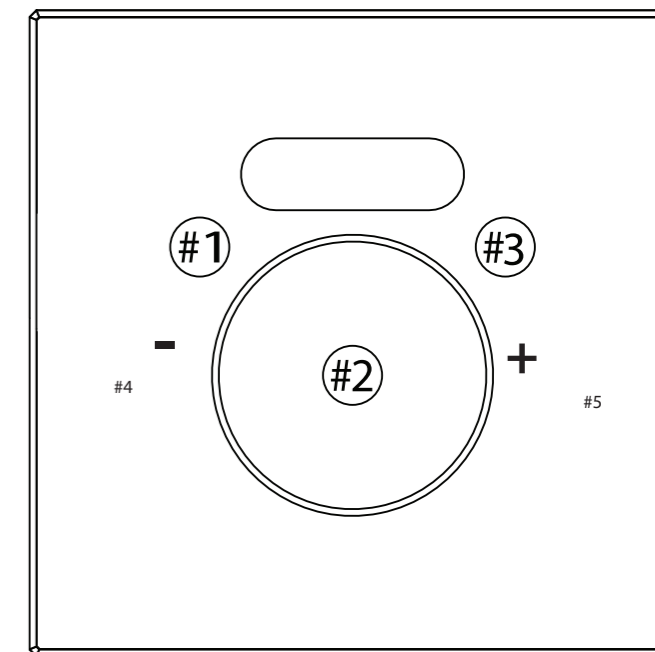

Special condition or status

LED	Colour codes	Description
LED #1	<i>blinks green for 5s</i>	<i>Valid HW signature detected at boot</i>
	<i>blinks red for 5s</i>	<i>Invalid HW signature detected at boot</i>
	<i>red glitch</i>	<i>When button #1 is touched indicates device is NOT included in the Z-Wave network</i>
	<i>Steady red</i>	<i>HW fault, contact assistance</i>

Normal operating condition or status

LED	Colour codes	Description
Any LED	<i>Steady blue</i>	<i>BASIC off or MULTILEVEL 0%</i>
	<i>Steady green</i>	<i>light dimming MULTILEVEL set at 33%</i>
	<i>Steady yellow</i>	<i>MULTILEVEL set at 100% or BASIC on</i>
	<i>Steady magenta</i>	<i>MOTOR control</i>

STANDARDS AND REGULATIONS

Electrical safety	(LVD) 2014/35/EU
Electromagnetic compatibility	(EMC) 2014/30/EU
Radio	(RED) 2014/53/EU
Presence of hazardous substances	(RoHS II) 2011/65/EU
Waste electrical and electronic equipment	(WEEE) 2012/19/EU

List of harmonized regulations applied

EN 301 489-1 V1.9.2; EN 301 489-3 V1.6.1
EN 50491-5-1:2010; EN 50491-5-2:2010
EN 60669-1:2000; EN 60669-1/A1:2003; EN60669-1/A2:2009
EN 60669-2-1:2004; EN 60669-2-1/A1:2009; EN 60669-2-1/A12:2009
EN 62479: 2010
EN 300 220-2 V.2.4.1

